



WALL

Bubble

The bubble is a family of 3D acoustic tiles with a hemispherical design for walls and ceilings. For the ceiling, one can use either convex or concave tile. The wall has three options: convex, light, or plant tile. The bubble tiles can be combined with flat tiles to create many different wall design possibilities. The tiles come in various shades from our updated color palette and can be painted in any desired shade.



THICKNESS

9 mm

SIZE

600x600 mm



Specifications	3
Models	4
Isometry	5
Light info	6
Planter info	7
Color Palette	8
Wood Collection	10
Installation	12



Manufactured From	Panels
Composition	100% Polyester (PET)
Sustainability	70% Recycled drinking bottles
Application	Wall covering
Fire Rating	EN13501-1 B S-1 d0
Size	600×600 mm
Thickness	9 mm (tolerance ±7%)
Installation	Varies
Acoustic	aw = 0.55
VOC	According to EN ISO 16000-9 Standard: A+
Pattern Repeat	Non-woven with a consistent pattern repeat. Despite slight variations due to fiber blending and lay-up, inherent to the product, it maintains uniformity in design, offering a unique yet coherent aesthetic.
Color Fading	Assessment of color fastness according to EN 1587 Assessed against the grey scale ISO-A02.
Care	Can be simply clean using a damp cloth and vacuum cleaner.

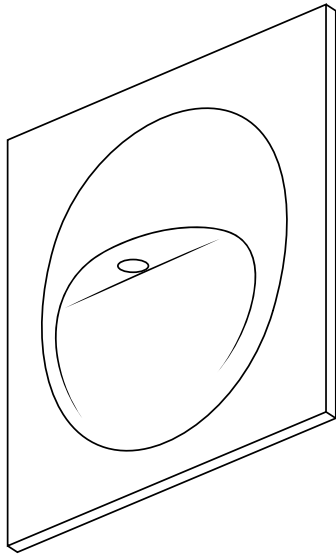

Bubble Light

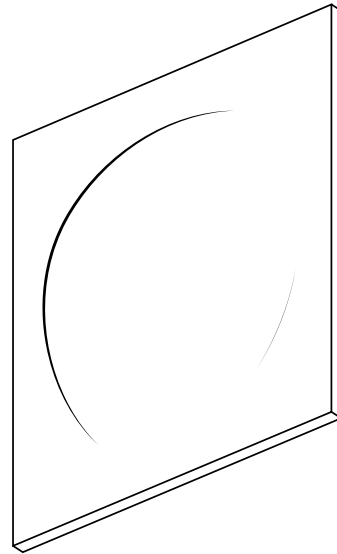

Bubble Convex

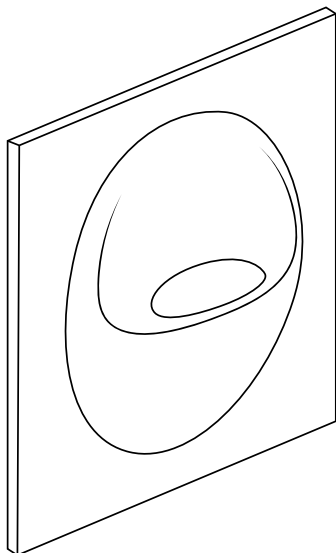

Bubble Plant



Bubble Light

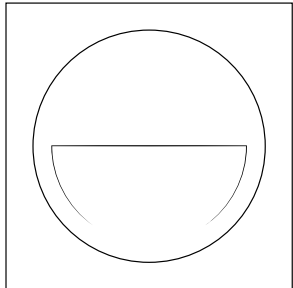

600 mm

600 mm

9 mm

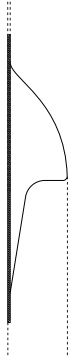

128 mm

Bubble Plant

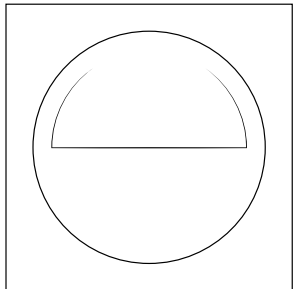

600 mm

600 mm

128 mm



9 mm

Bubble Convex

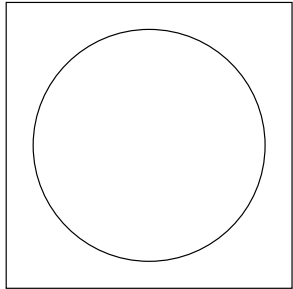

600 mm

600 mm

128 mm



9 mm

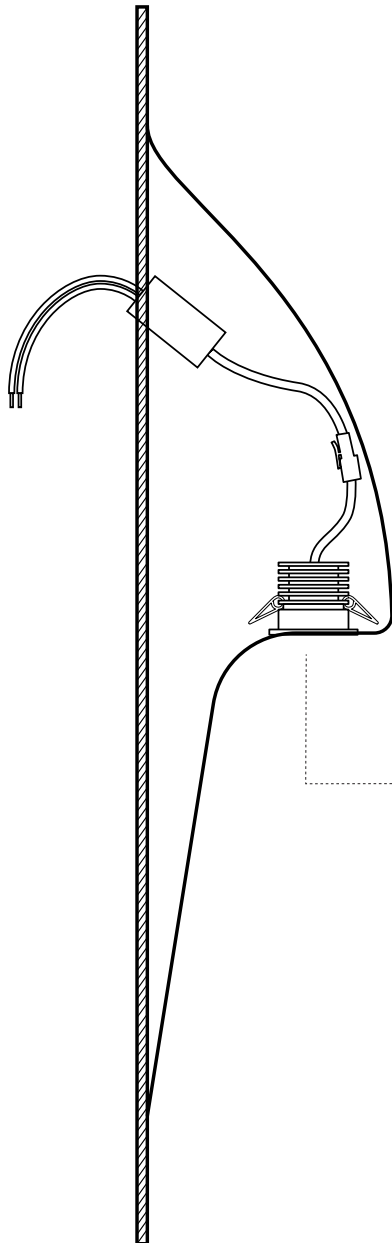

Radius	37 mm
Height	24 mm
Socket	E27

NOTE 1

The light fixture pulls out from the front of the Bubble in case of a fault.

NOTE 2

every light fixture has its own driver and electrical cord in order to chain connect them all.

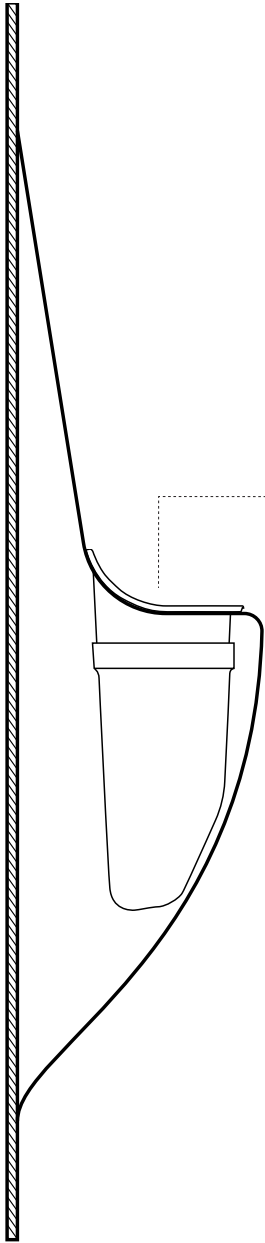

Width	220 mm
Height	140 mm
Depth	60 mm
Volume	1 L

NOTE 1
The planter pulls out from the front of the Bubble for watering and maintenance.



Light Grey
EP28



White
EP24



Cream
EP43



Beighe
EP07



Mocca
EP14



Taupe
EP22



Sea Sand
EP208



Olive Leaf
EP207



Grey Stone
EP206



Autumn Green
EP45

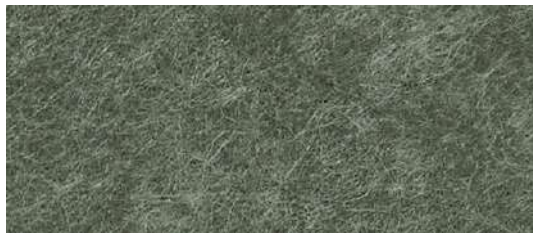

Gray Khaki
EP93

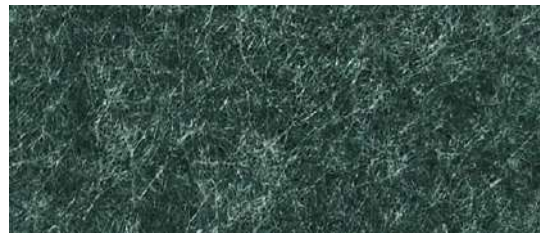

Cypres Tree
EP803



Silver
EP03

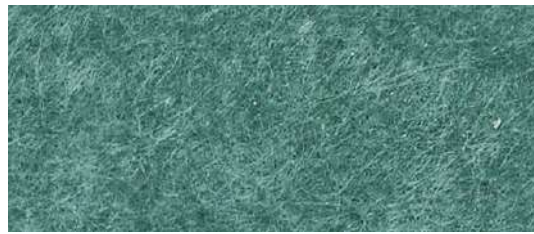

Forest Green
EP103



Ash
EP04



Rose Shadow
EP405



Cherry
EP123



Red
EP25



Yellow
EP11



Orange
EP06

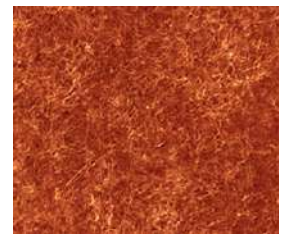

Terra Cotta
EP125



Bright Horizon
EP608



Blue Sky
EP605



Blue Ocean
EP50



Light Blue
EP05



Blue Jeans
EP92



Dark Grey
EP18



Dark Blue
EP51



Black Berry
EP57

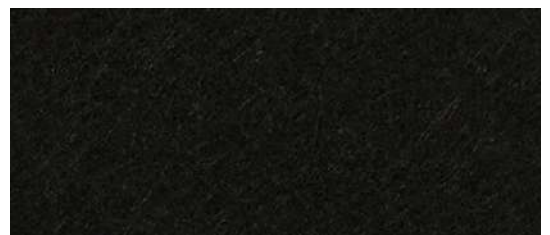

Black
EP09



Strip Wenge
EPW0202N



American Walnut
EPW0203N



Teak
EPW0302N



Strip American Cherry
EPW0304N



Strip European White Oak
EPW0401N



Flower European White Oak
EPW0402N



Split Oak
EPW0404N



European White Oak
EPW0405N



Strip White Oak
EPW0407N



Smoked Oak
EPW0408N



Strip Maple
EPW0504N



Strip Greige Oak
EPW0702N



PREPARATIONS

Make sure that the wall on which you are installing the Bubble is leveled or distanced equally, and prepare construction silicon.

STEP 1

Apply a strip of silicon to the back of the Bubble tile.





STEP 2

Glue each tile while one stud is at the center of the tile and the two on each edge.



STEP 3

Repeat the process for the entire wall.

