

Hygiene E system

600x600, 1200x600,
625x625, 1250x625

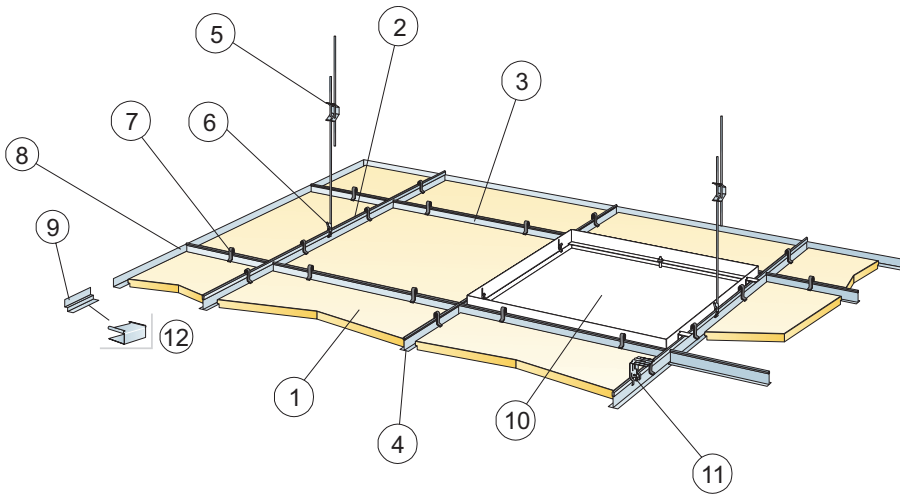
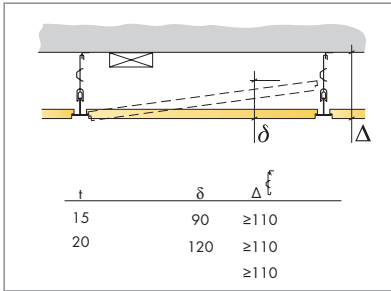

1. Ecophon Hygiene E panel 600x600/1200x600
625x625/1250x625

2. Connect T24 Main runner

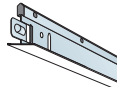

3. Connect T24 Cross tee,
L=1200/1250

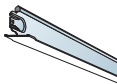

4. Connect T24 Cross tee,
L=600/625

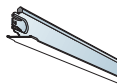

5. Connect Adjustable hanger



6. Connect Hanger clip



7. Connect Direct fixing bracket



8. Connect Angle trim

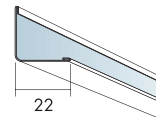

9. Connect Shadow-line
trim

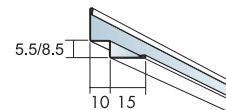

10. Connect E-plugg





Connect Inspection hatch C3 (600x600)

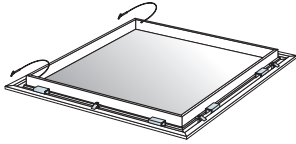

Connect Inspection hatch C3 (1200x600)



Bild på C1 hygiene lucka

Ecophon[®]
SAINT-GOBAIN

A SOUND EFFECT ON PEOPLE

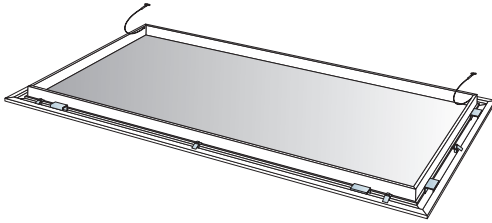
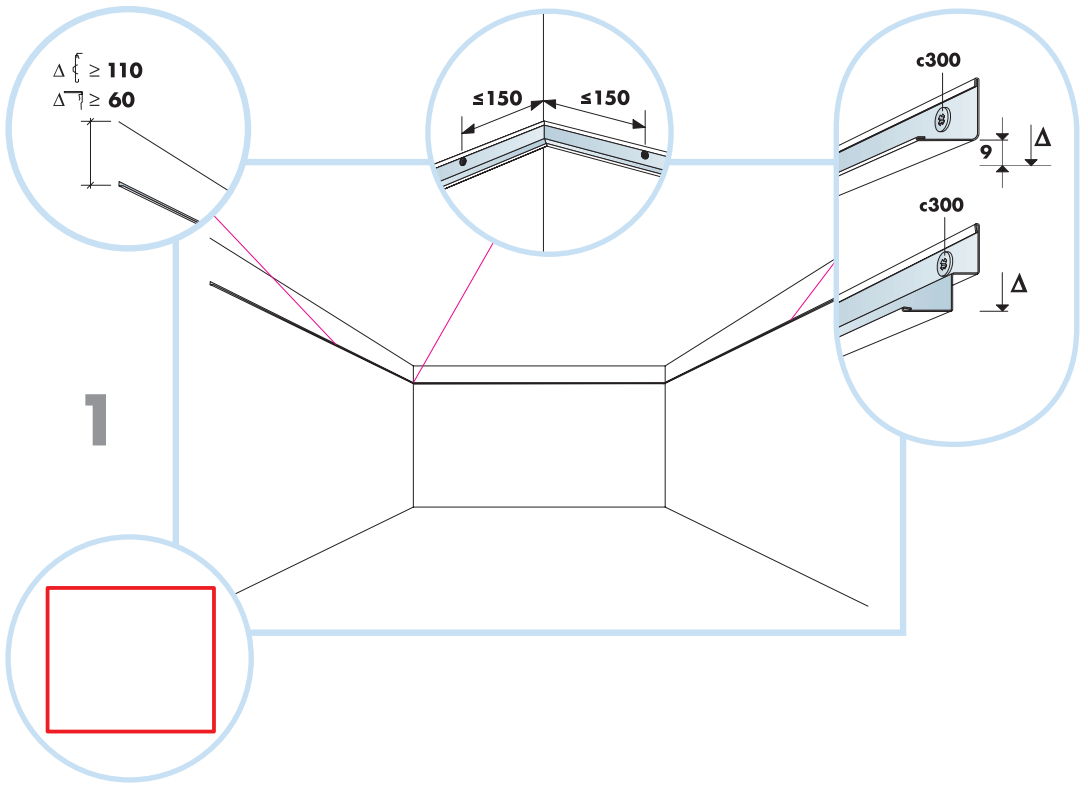

2

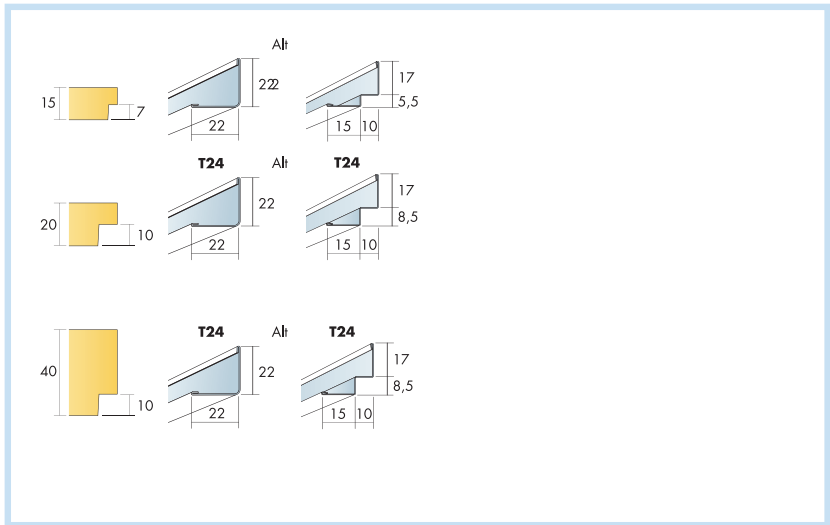

3

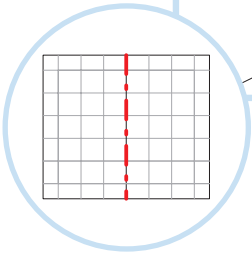
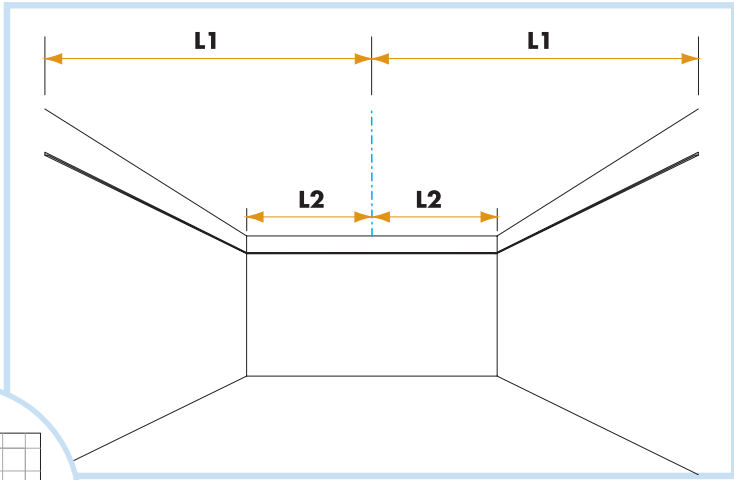

$A < 300$

4

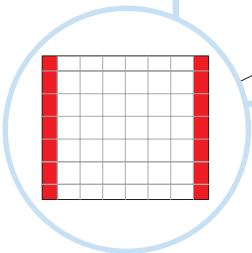
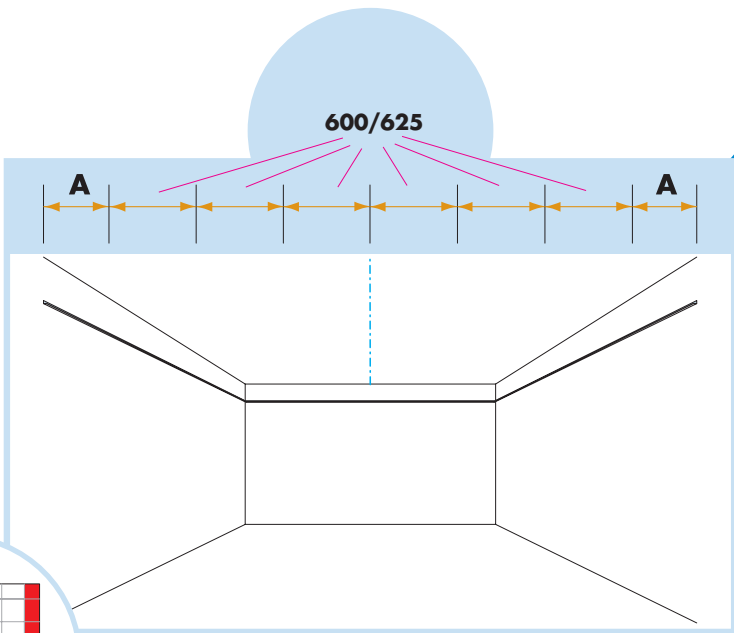

$A \geq 300$

5

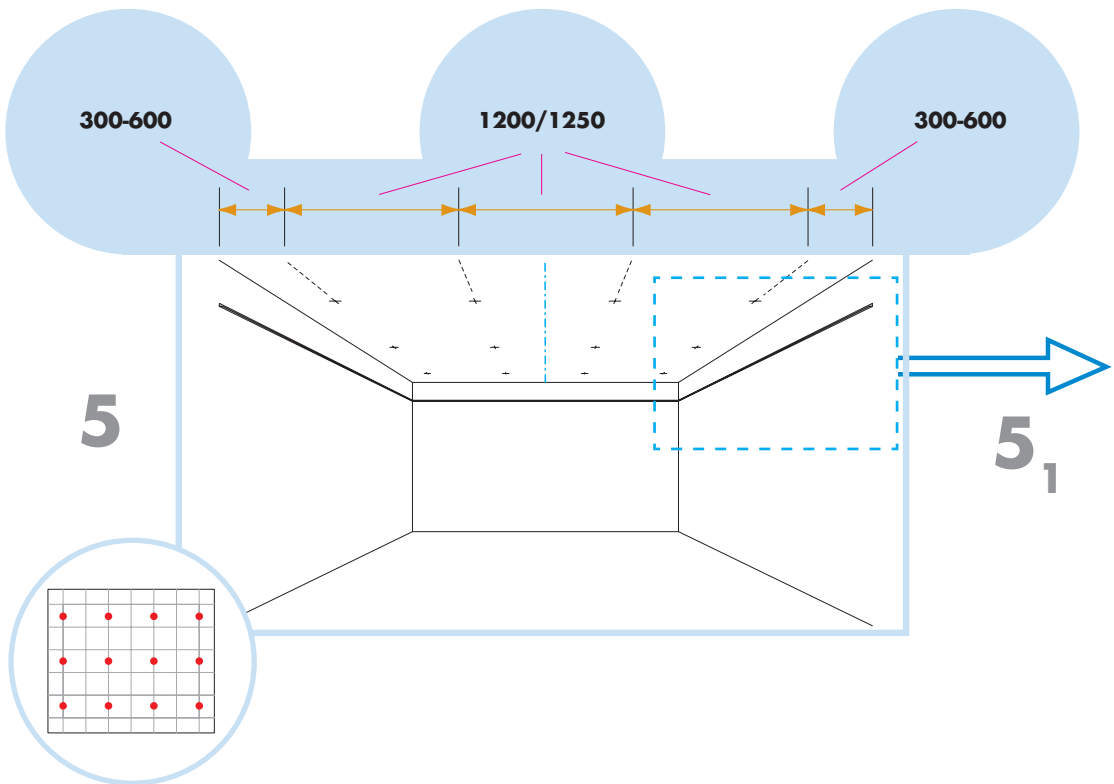
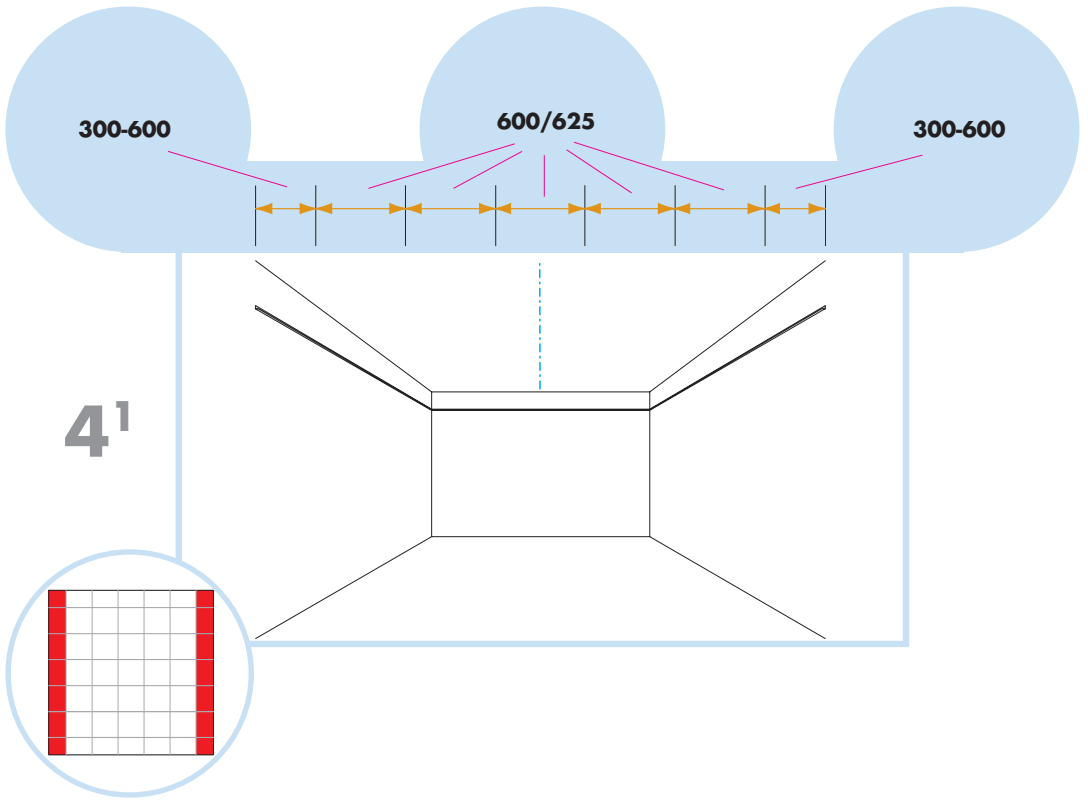

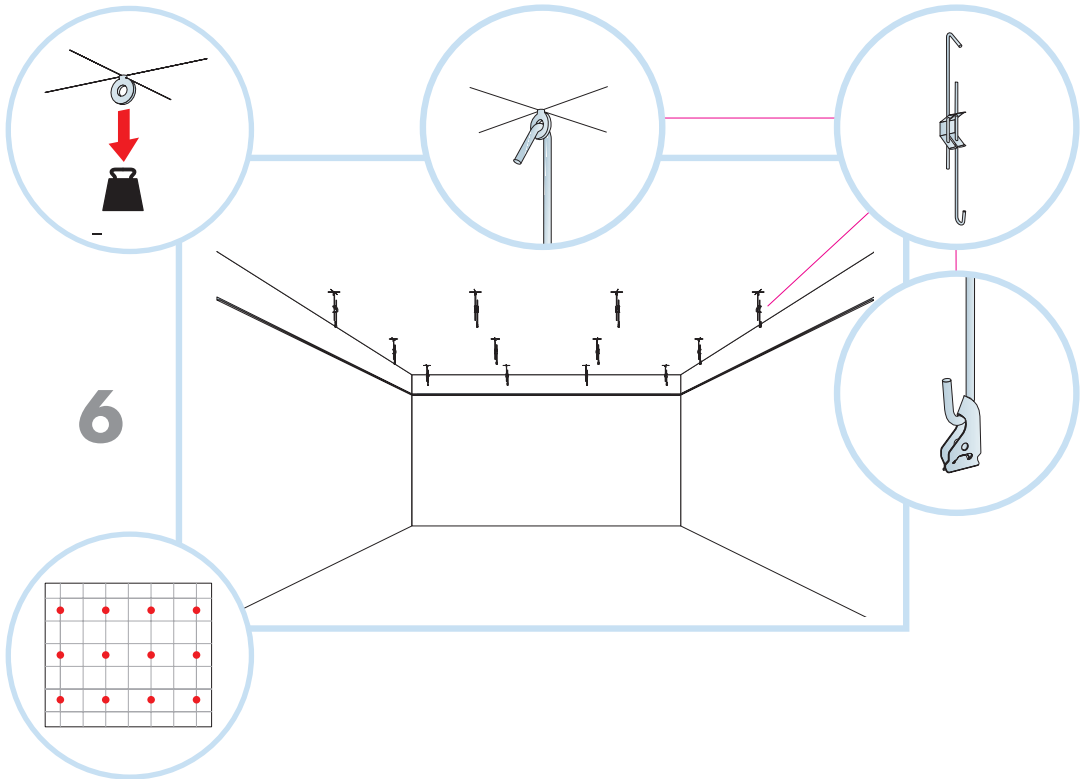
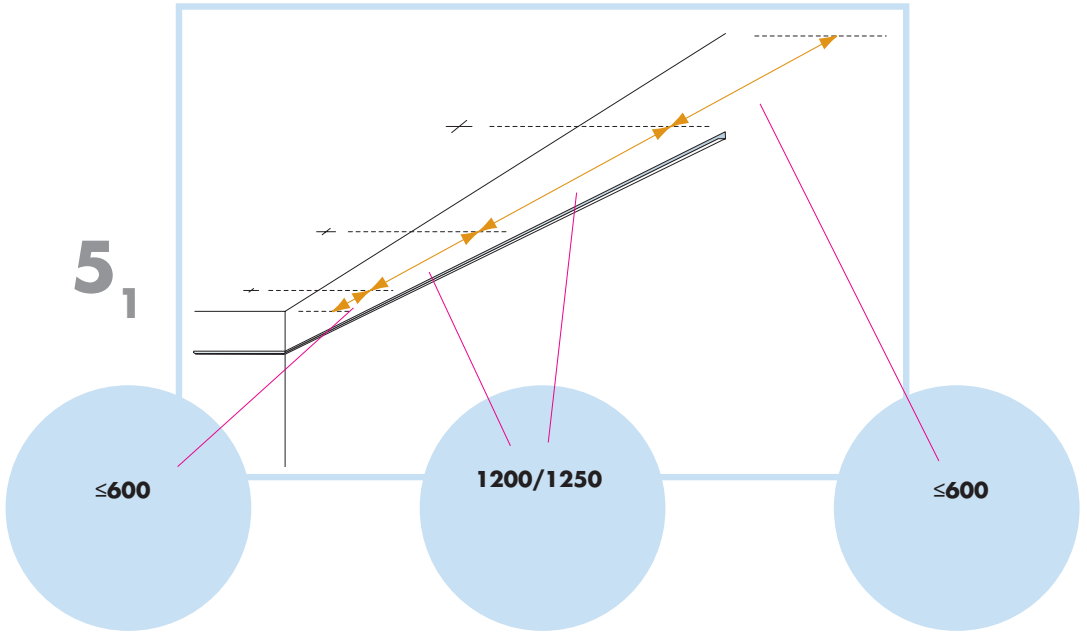

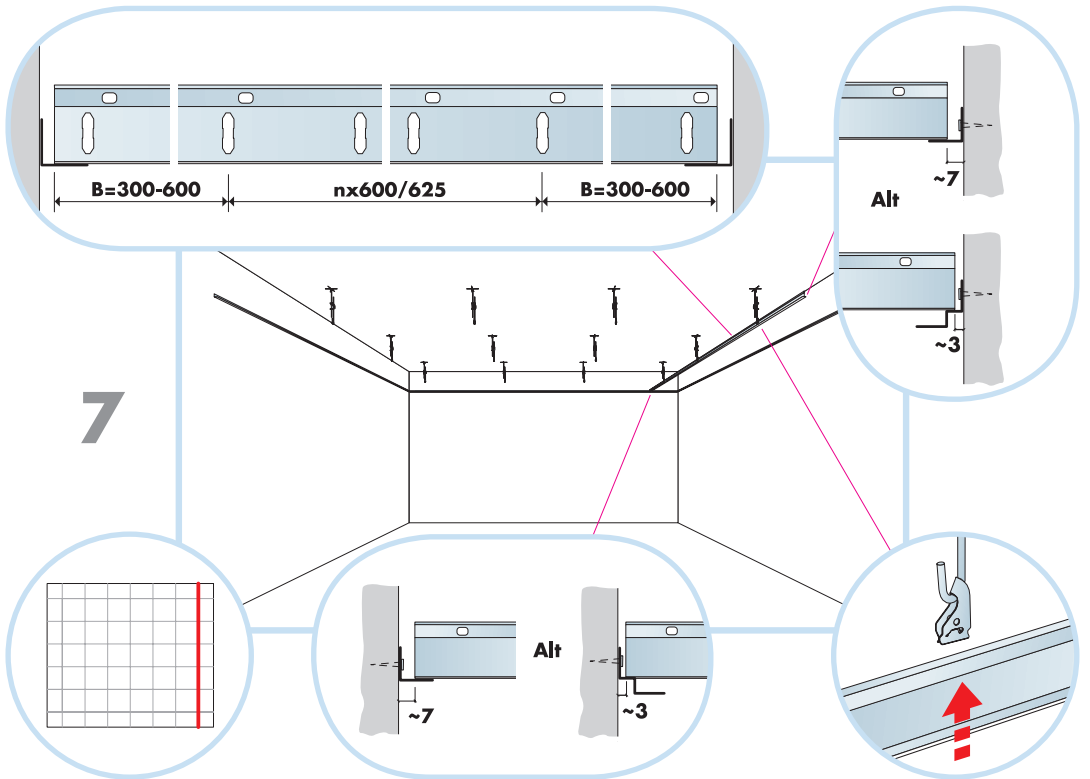

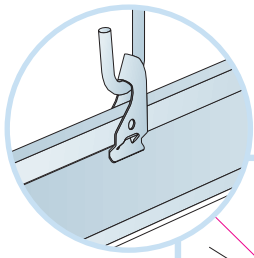

8

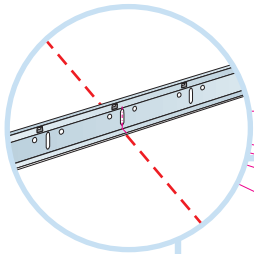
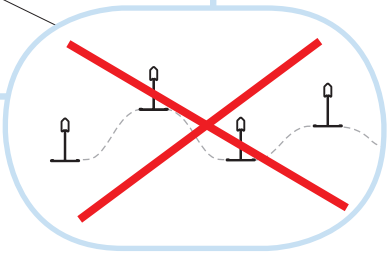
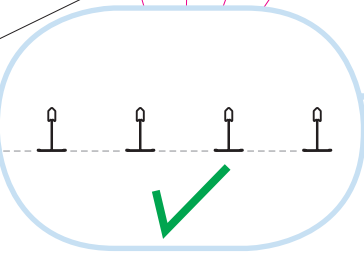
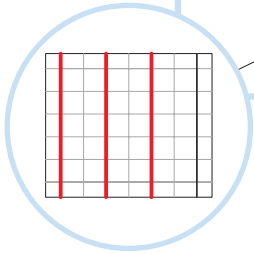
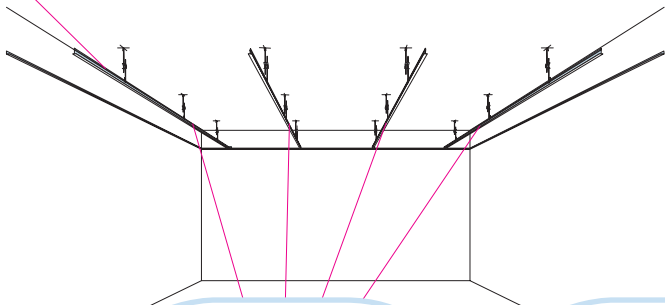

8₁

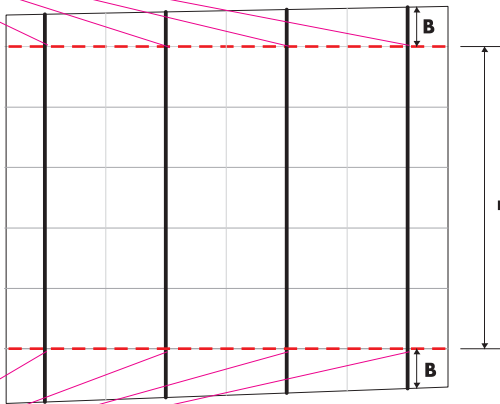

Connect Laser angle

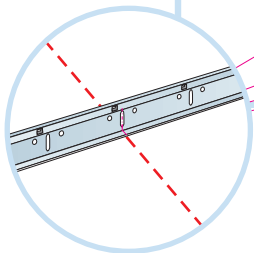
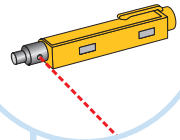

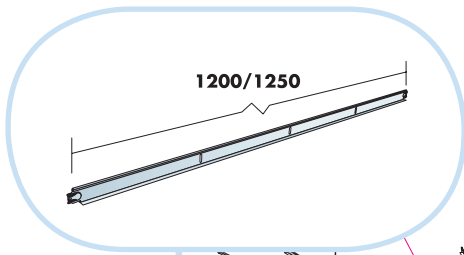

9

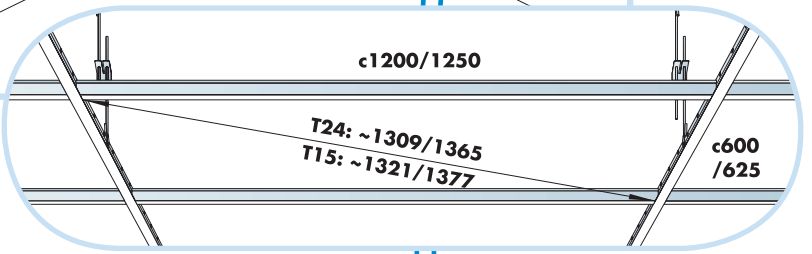
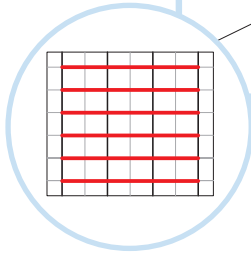
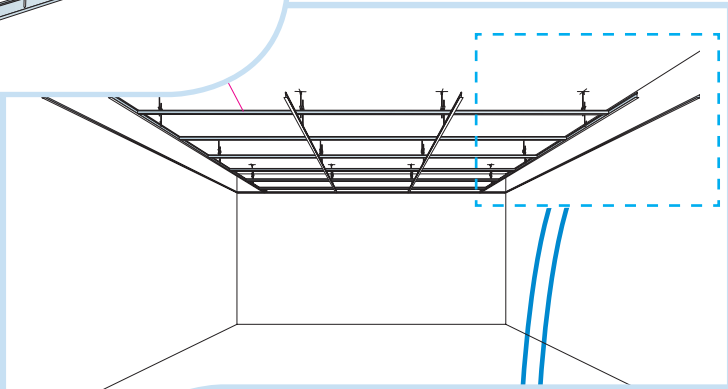



9₁

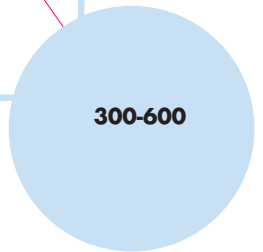
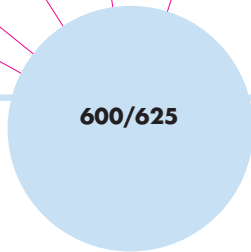
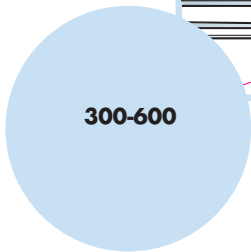
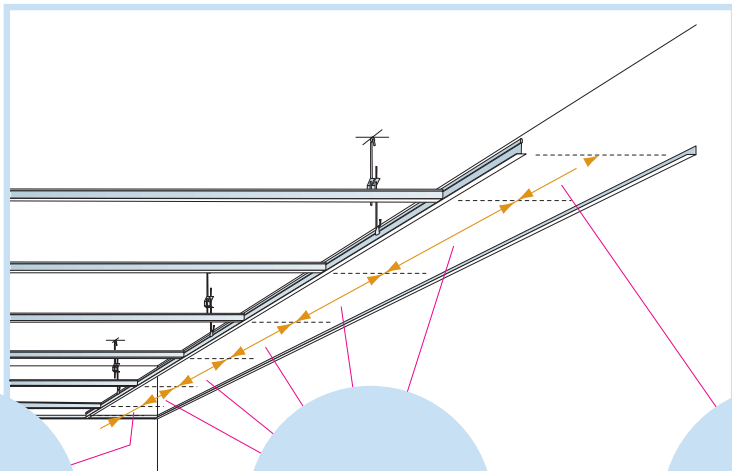

9₁

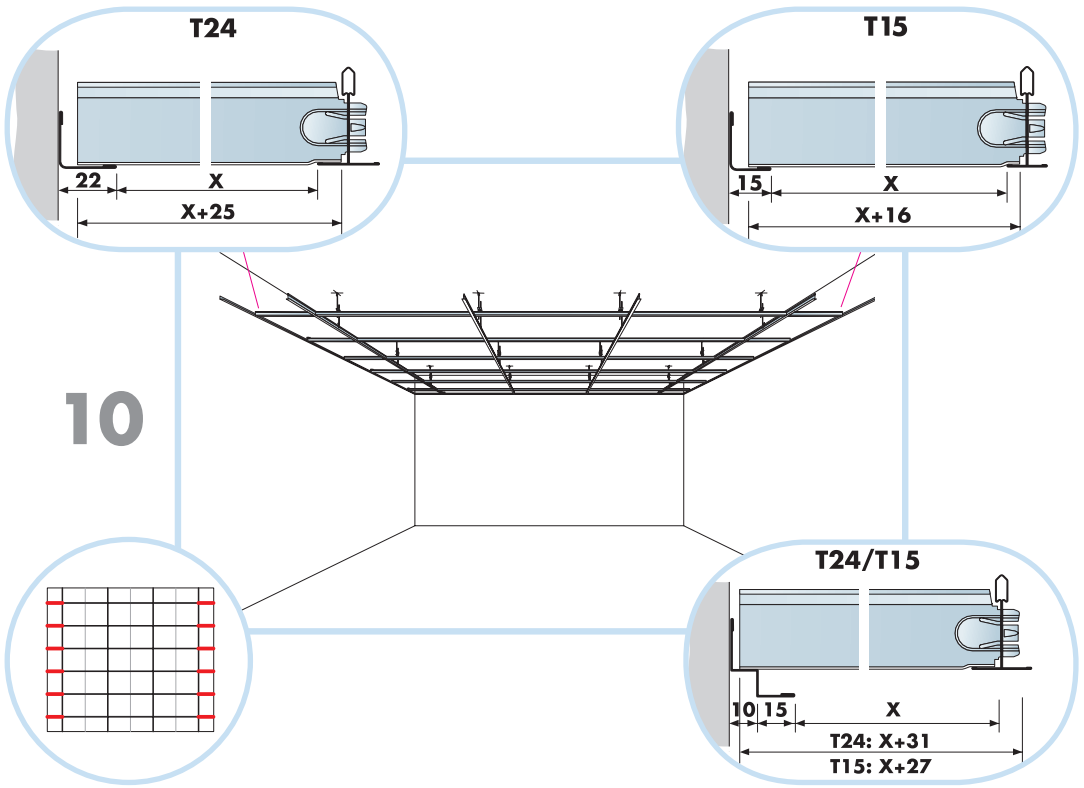



600x600/625x625  

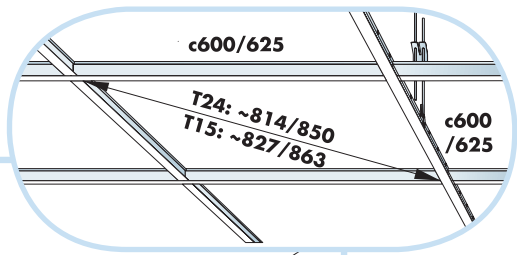
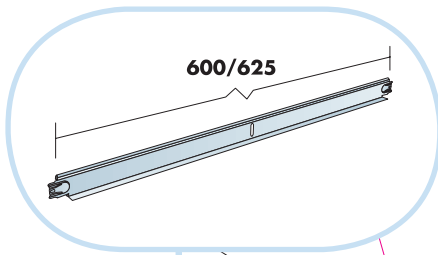

11

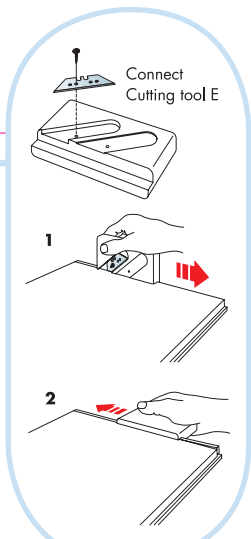
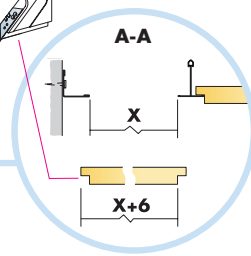
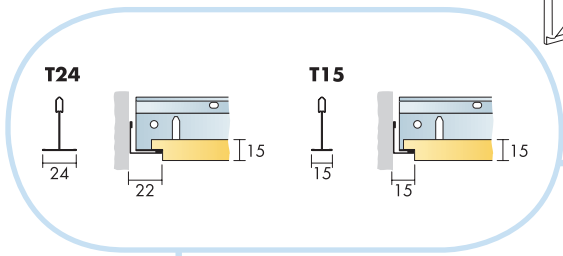
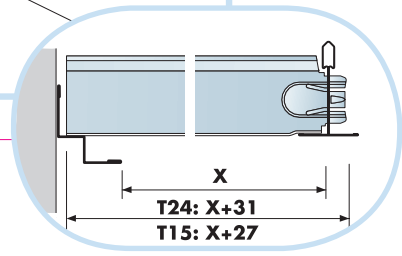
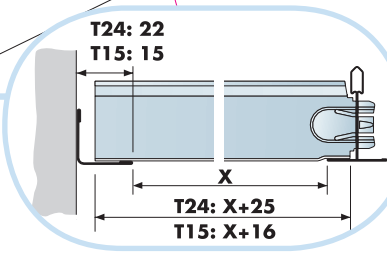
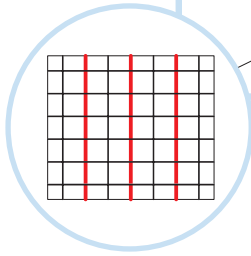
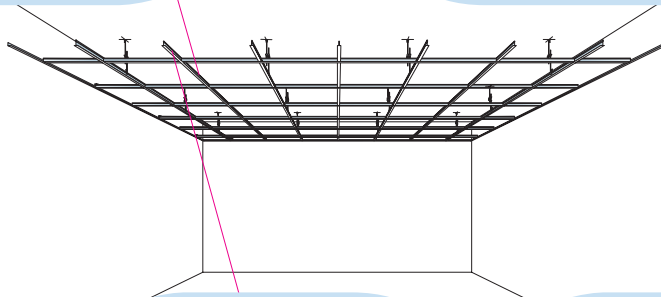

12

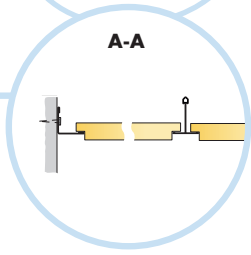
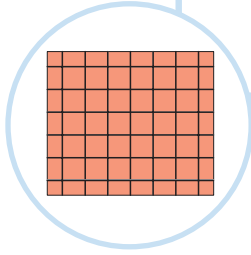
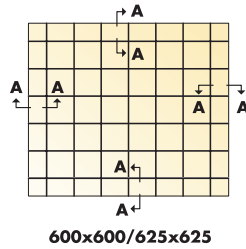
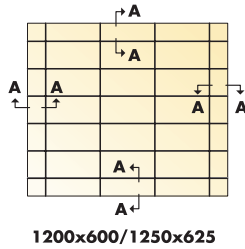

T24

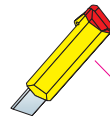
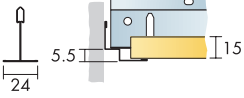

A-A

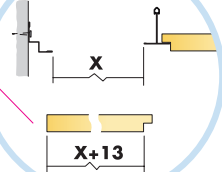

15

13

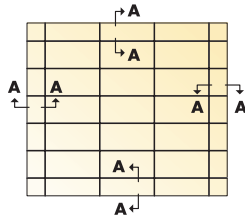

1200x600/1250x625

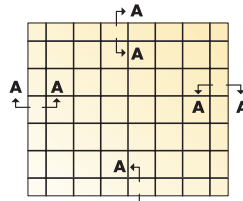

600x600/625x625

A-A

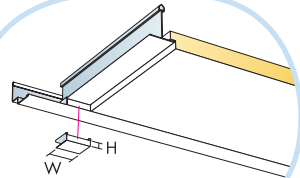
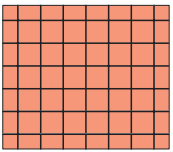
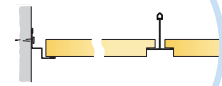

W H

T24: H=5.5 W=25
T15: H=5.5 W=16

T24

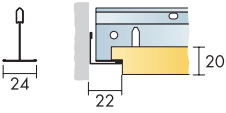

T15

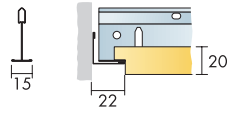

A-A

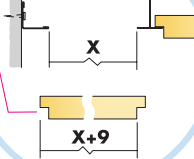

Connect Cutting tool E

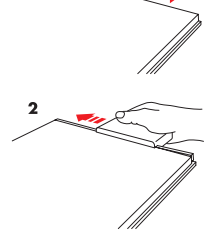

20

14

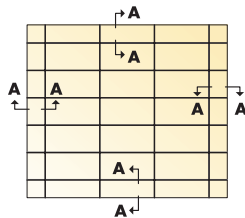

1200x600/1250x625

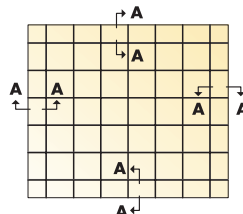

600x600/625x625

A-A

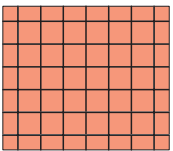
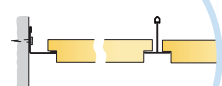

T24

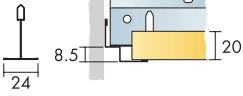

T15

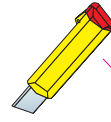
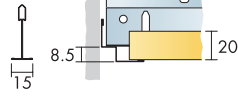

A-A

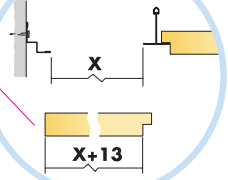

15

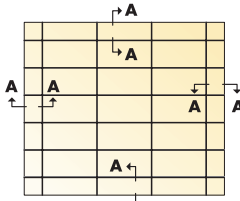

1200x600/1250x625

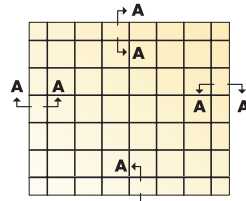

600x600/625x625

A-A

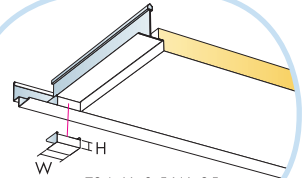
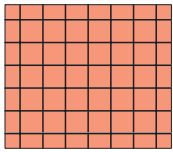

T24: H=8.5 W=25
T15: H=8.5 W=16

T24

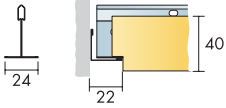

T15

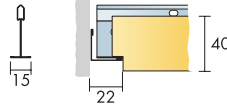

A-A

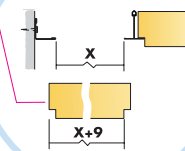

Connect Cutting tool E

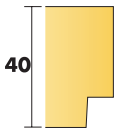

16

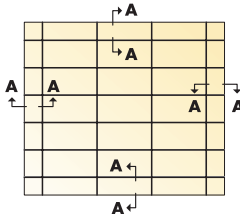

1200x600/1250x625

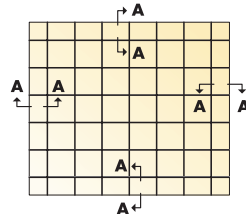

600x600/625x625

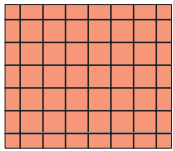
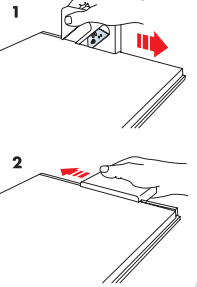
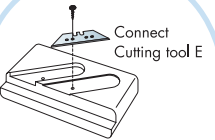

A-A



T24

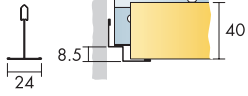

T15

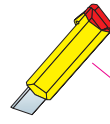
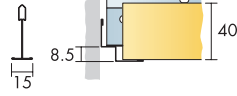

A-A

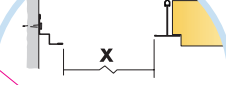

X+13



A-A

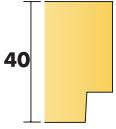

17

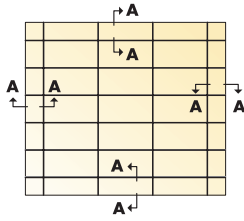

1200x600/1250x625

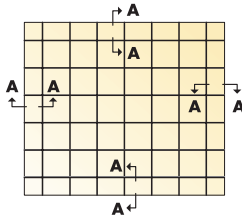

600x600/625x625

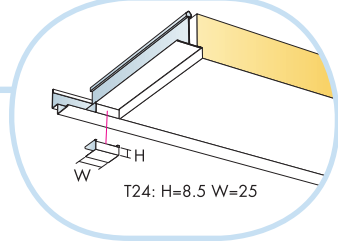
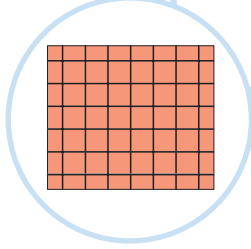

T24: H=8.5 W=25

12

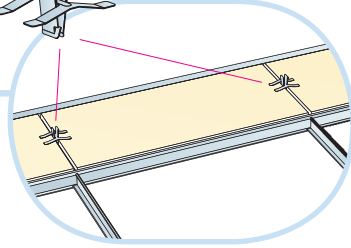
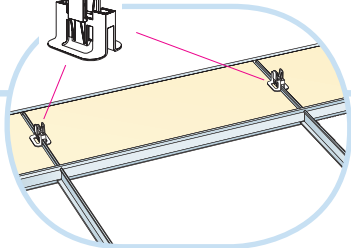
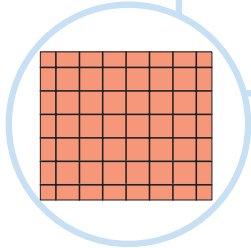
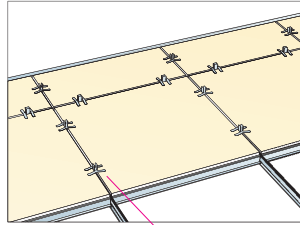
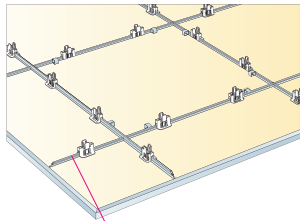

13

