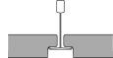
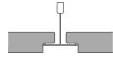
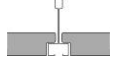

# FOCUS E

## תקרה חצי שקועה

מערכת תקרה אקוסטית עם אריחים המותקנים על קונסטרוקציה חצי שקועה. הקצה השקוע יוצר אפקט של צל המדגיש כל אריח ומסתיר חלקית את הקונסטרוקציה הגלויה. מיועד לחללים הדורשים מראה מעוצב לצד צורך בפירוק נוח של אריחים בודדים. האריחים בעובי 20 מ"מ, במשקל כולל פרופילציה 3 ק"ג/מ"ר.

30x120	60x240	60x200	60x180	30x180	60x160	120x120	60x120	61x61	60x60		
						•	•		•		T15
•	•	•	•	•	•	•	•	•	•		T24
							•		•		פיין ליין

\*יש לבדוק זמינות מלאי

THK mm	o.d.s mm	Practical sound absorption coefficient						aw	Sound absorption class
		125 Hz	250 Hz	500 Hz	1000 Hz	2000 Hz	4000 Hz		
20	60	0.15	0.55	0.90	1.00	1.00	1.00	0.85	B
20	200	0.50	0.90	0.90	0.90	1.00	1.00	0.95	A

THK mm	o.d.s mm	NRC	SAA
20	60	0.90	0.87
20	400	0.85	0.85

Focus E 20 mm, 60 mm O.D.S. ....  
Focus E 20 mm, 200 mm O.D.S. -  
O.D.S. = Overall Depth of System

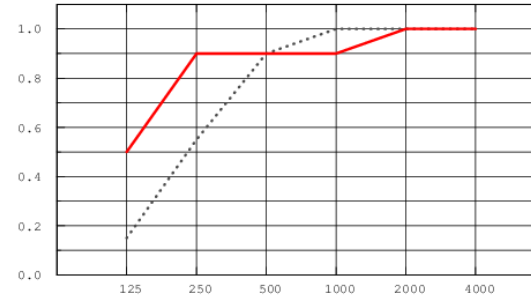

**בליעת רעש  $\alpha$  - 0.95**  
מקדם בליעת קול משוקלל  
לפי תקן אירופאי



**עמידות בלחות**  
עד 95% לחות יחסית



**מאושר לשימוש**  
ע"י האיגוד השוודי לחקר  
האסטמה והאלרגיה



**VOC תרכובות אורגניות נדיפות**  
דרגה M1 המציינת את האיכות הגבוהה  
ביותר ואת הפליטה הנמוכה ביותר של  
חלקיקים וכימיקלים מזיקים



**תכולת חומר ממוחזר**  
מעל 70%



**התקנה**  
על גבי פרופיל מסוג:  
T24 / T15 / פיין ליין



**ניקוי האריחים**  
באמצעות מטלית לחה ושואב אבק



**תגובות בשריפה**  
ע"פ ת"י A2-s1, d0 - 755



**החזר אור**  
85%

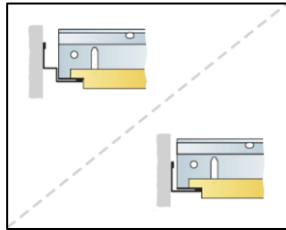
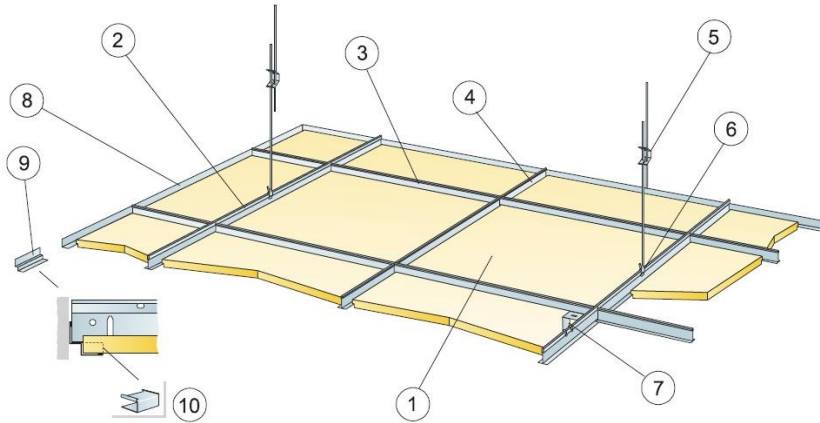

Regular rebate with angle trim and T-profile on foot of shadow-line trim.

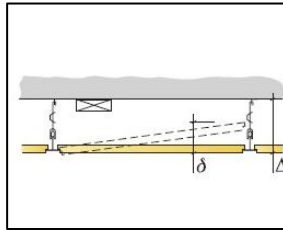

See Quantity specification

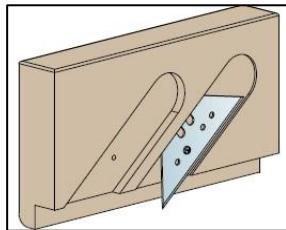

Cutting tool E.

Size, mm	Max live load (N)	Min load bearing capacity (N)
600x600x20	50	160
1200x600x20	50	160
1200x1200x20	50	160

Live load/load bearing capacity.

**Quantity specification (excl. wastage)**

	Size, mm		
	600x600	1200x600	1200x1200
1 Focus E T24 or T15	2, 8/m <sup>2</sup>	1,4/m <sup>2</sup>	0,7/m <sup>2</sup>
2 Connect T24 or T15 Main runner, installed at 1200 mm centres (max. distance from wall 600 mm, can be extended up to 1200 mm if no live load between Main runner and wall).	0,9/m <sup>2</sup>	0,9/m <sup>2</sup>	0,9/m <sup>2</sup>
3 Connect T24 or T15 Cross tee, L=1200 mm	1,7/m <sup>2</sup>	1,7/m <sup>2</sup>	0,9/m <sup>2</sup>
4 Connect T24 or T15 Cross tee, L=600 mm	0,9/m <sup>2</sup>	-	-
5 Connect Adjustable Hanger, installed at 1200 mm centres (max. distance from wall 600 mm)	0,7/m <sup>2</sup>	0,7/m <sup>2</sup>	0,7/m <sup>2</sup>
6 Connect Adjustable Hanger, installed at 1200 mm centres (max. distance from wall 600 mm) Connect Hanger Clip (not to be used in swimming hall environments)	0,7/m <sup>2</sup>	0,7/m <sup>2</sup>	0,7/m <sup>2</sup>
7 For direct installation: Connect Direct Bracket, installed at 1200 mm centres	0,7/m <sup>2</sup>	0,7/m <sup>2</sup>	0,7/m <sup>2</sup>
8 Connect Angle trim, fixed at 300 mm centres	as required	as required	as required
9 Connect Shadow-line trim, fixed at 300 mm centres	as required	as required	as required
10 Connect E-plug (for Shadow-line trim)	as required	as required	as required

A Min. overall depth of system, with adjustable hanger: 110 mm, with direct bracket: 60 mm

8 Min. demounting depth: 120 mm, (1200x1200 mm, T15: 160 mm)

For luminaire integration in panels use Connect Bridging



White Frost



Deep Sea



Sage Mist



Morning Rain



Scallop Shells



Spring Leaf



Pine Green



Wet Sand



Silent Steam



Dark Diamond



Cloudy Day



Volcanic Ash



Silver Stone



Silk Slate



Dark Chestnut



Basalt Rock