

CEILINGS

## INSTALLATION GUIDE

# Diagonal

A combination of frames and tiles that create a three-dimensional ceiling surface and excellent acoustics. A selection of shades from an existing fan of colors. Can be painted in any desired shade.

THICKNESS

12 mm

LENGTH

60x60 cm

HEIGHT

5-15 cm

## DIMENSIONS

---

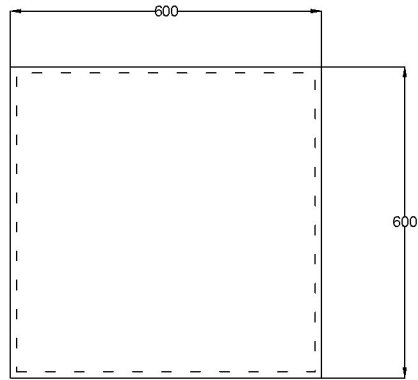

### Box

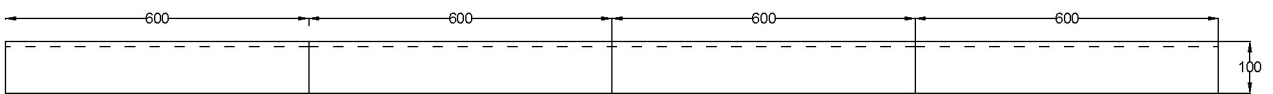

### Hill

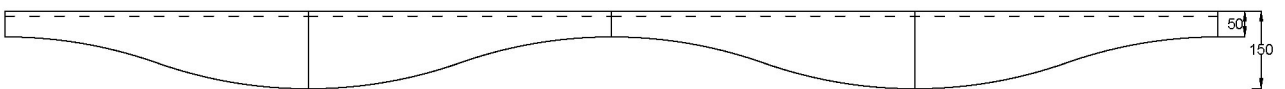

### Vertex

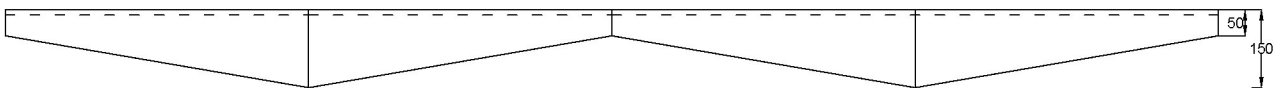

**ISOMETRY**

---

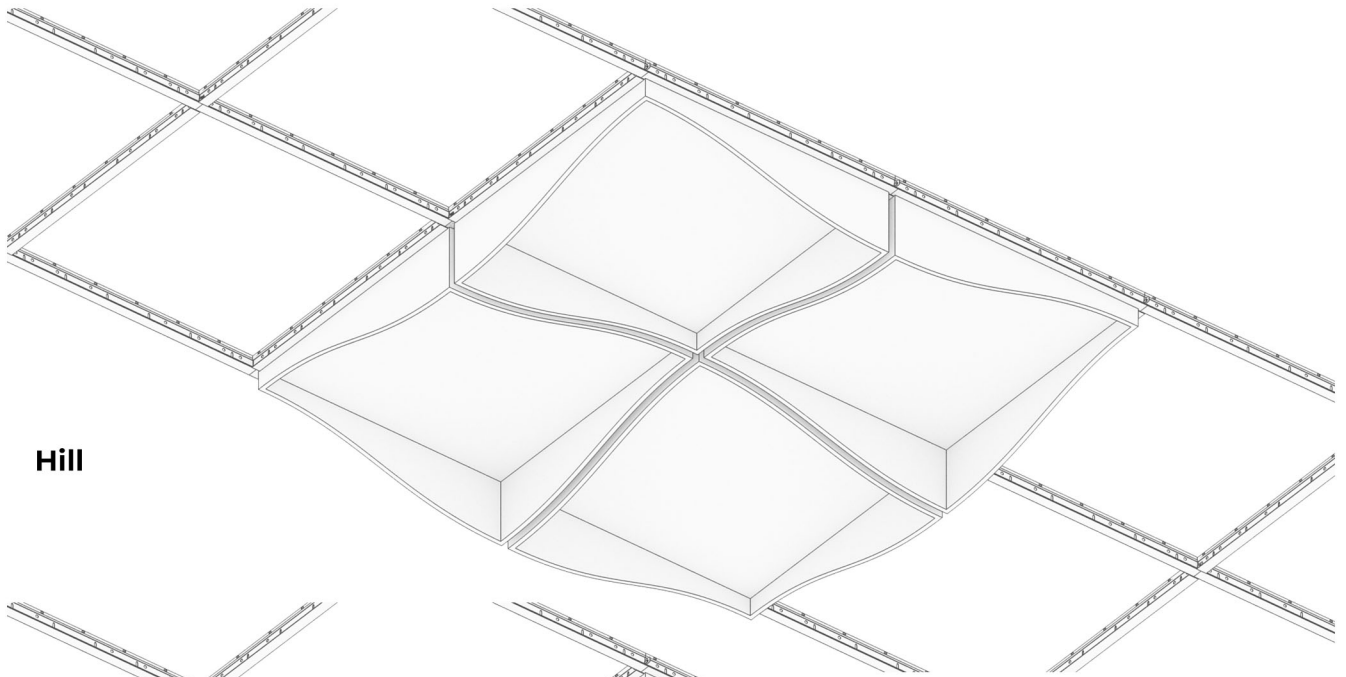

**Hill**

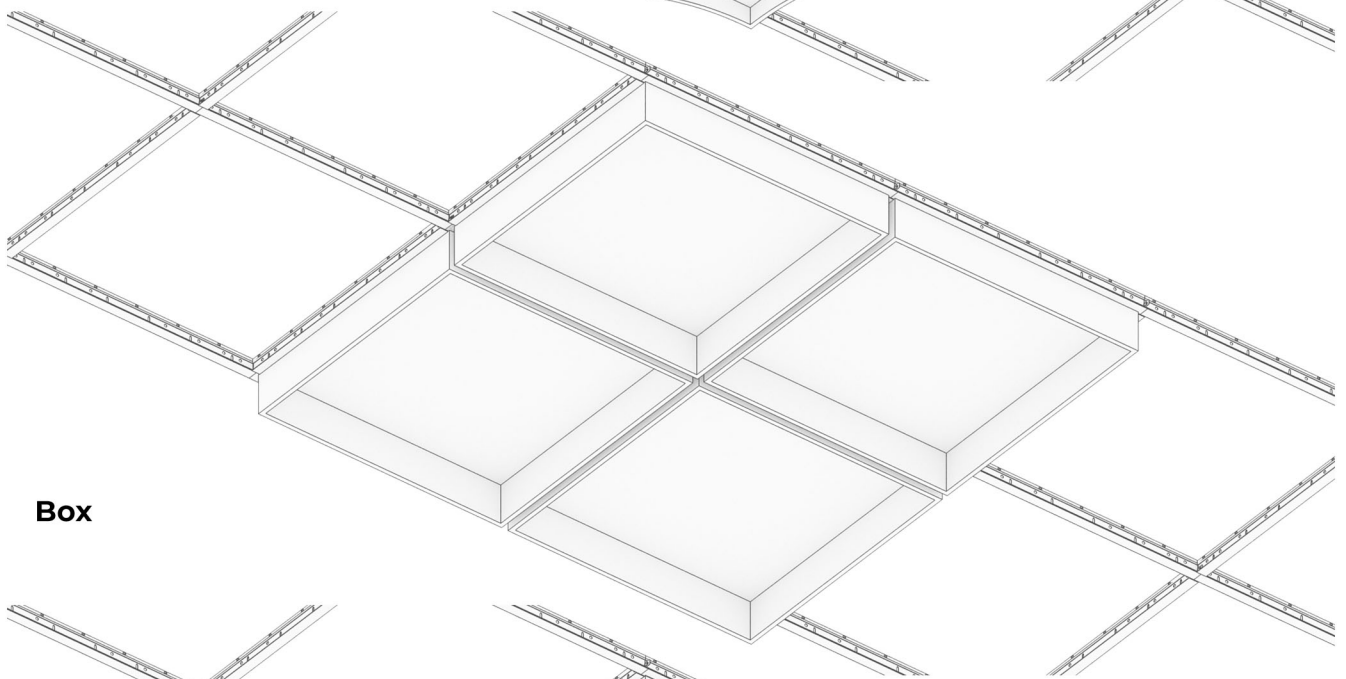

**Box**

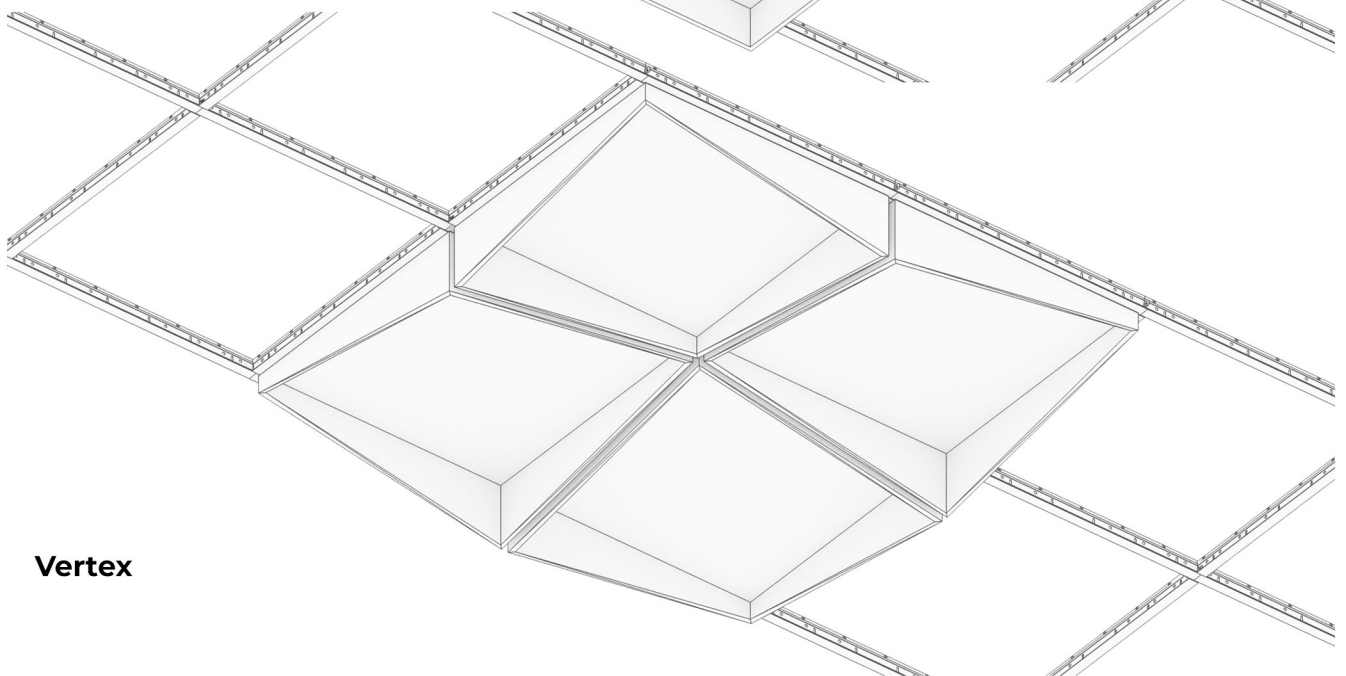

**Vertex**

INSTRUCTIONS

# These are your parts.

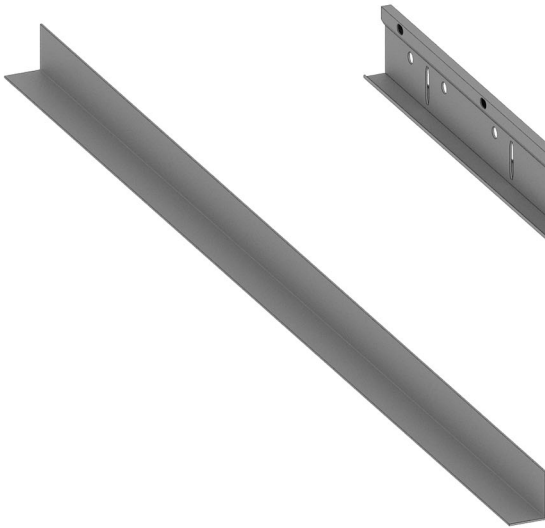

**L Profile**  
optional

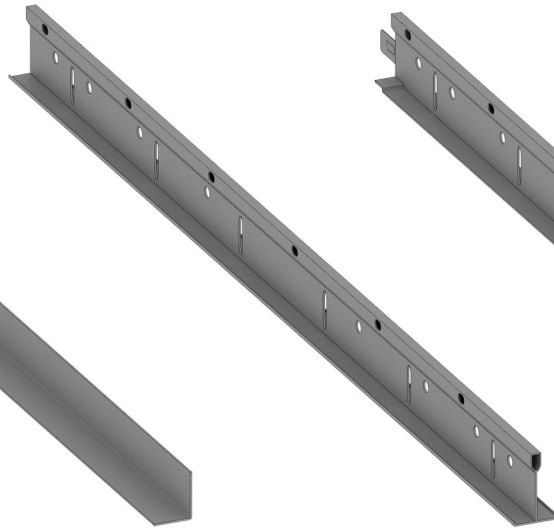

**T24 Main Profile**

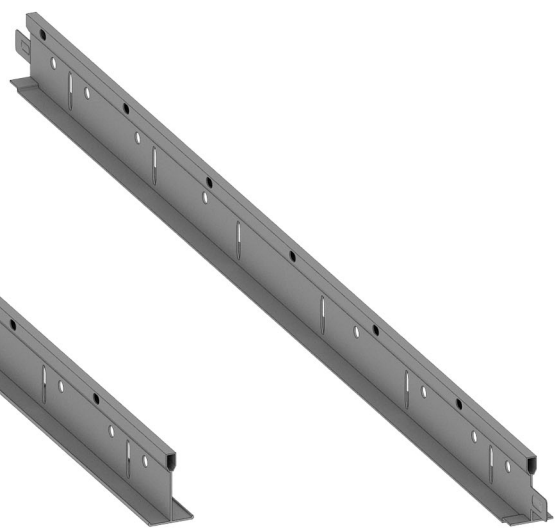

**T24 Side Profile**



**Tile**



**Adjustable Hanger**

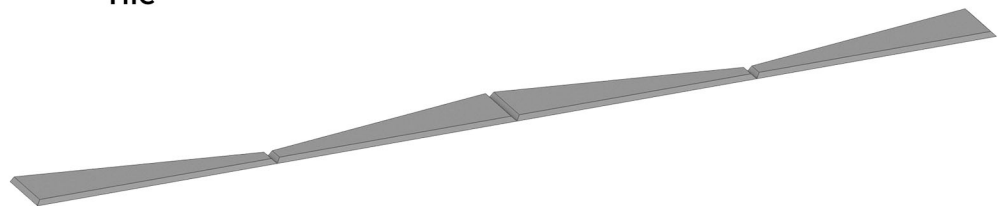

**Frame**

- ① **Mark the construction line on the ceiling and screw the hangers following the lines.**

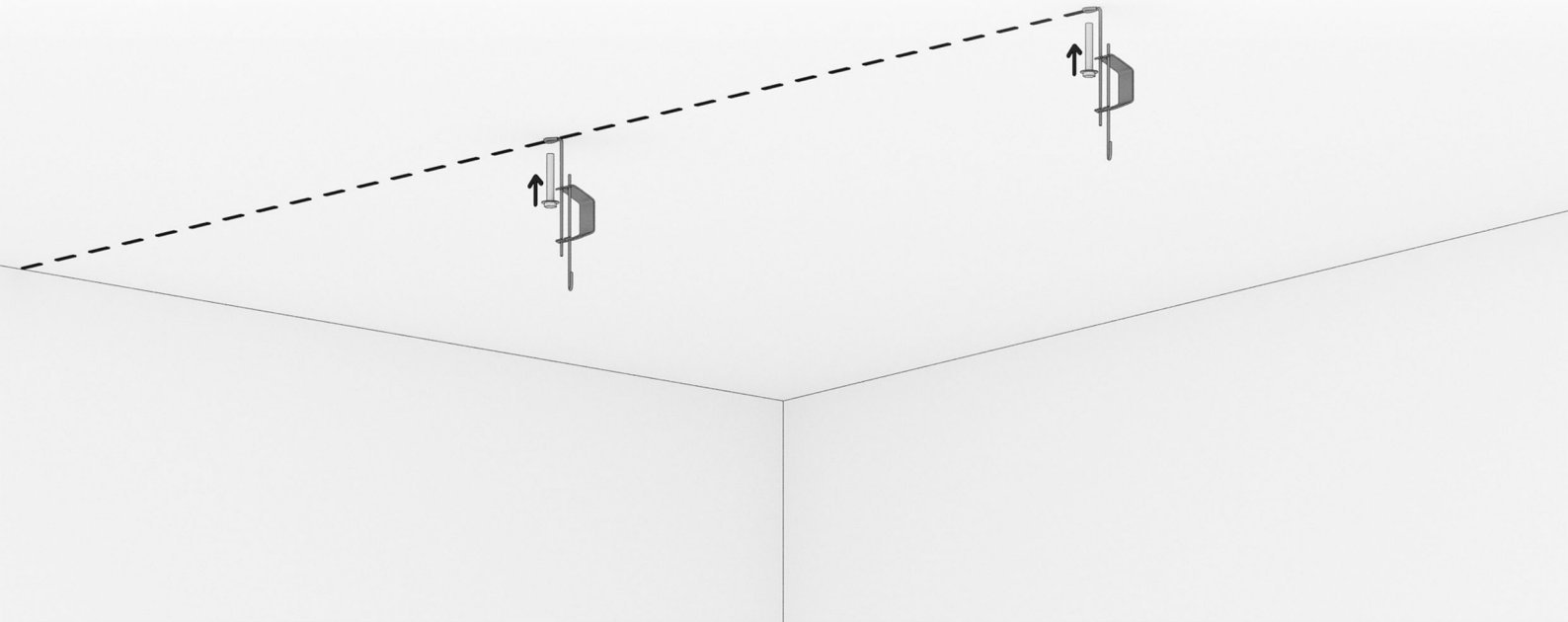

- ② **Install the T24 main profile on the hangers.**

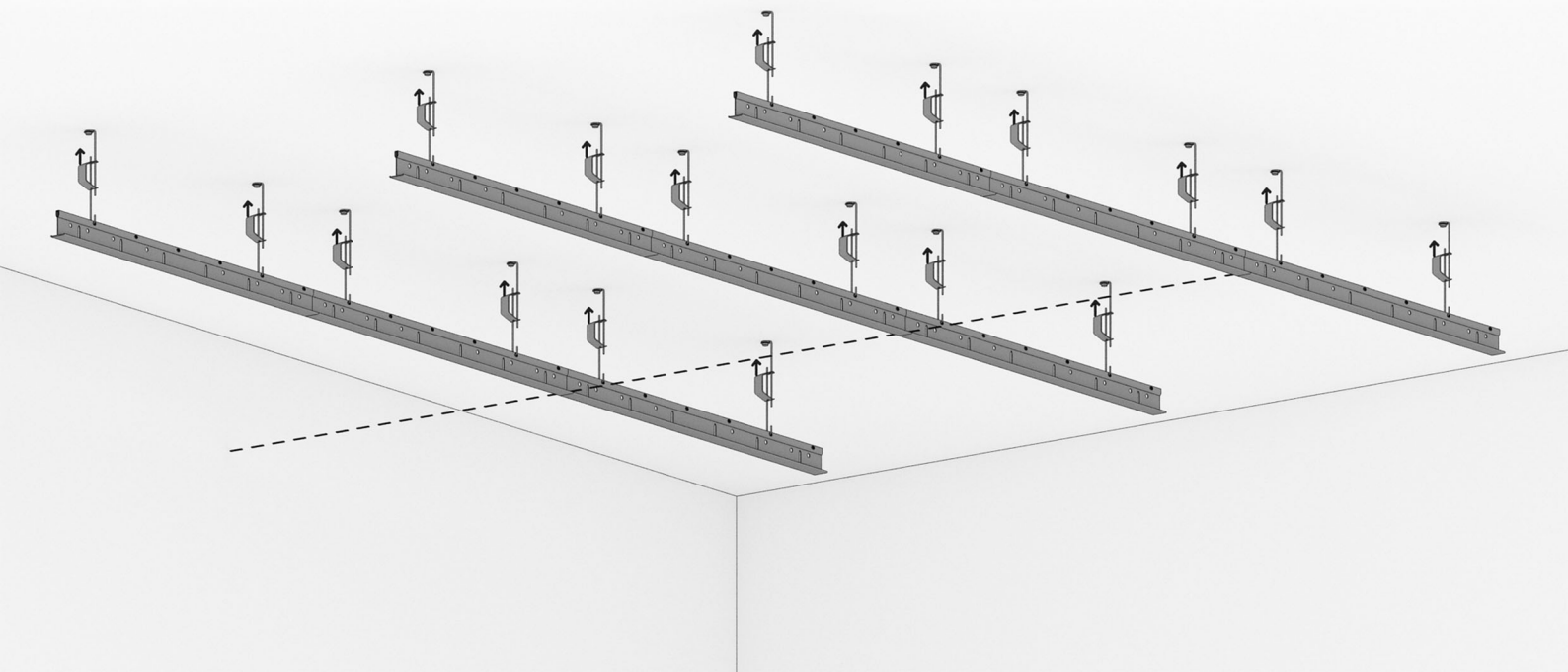

- ③ **Install the T24 side profiles between the mains, keeping 60 cm from each other.**

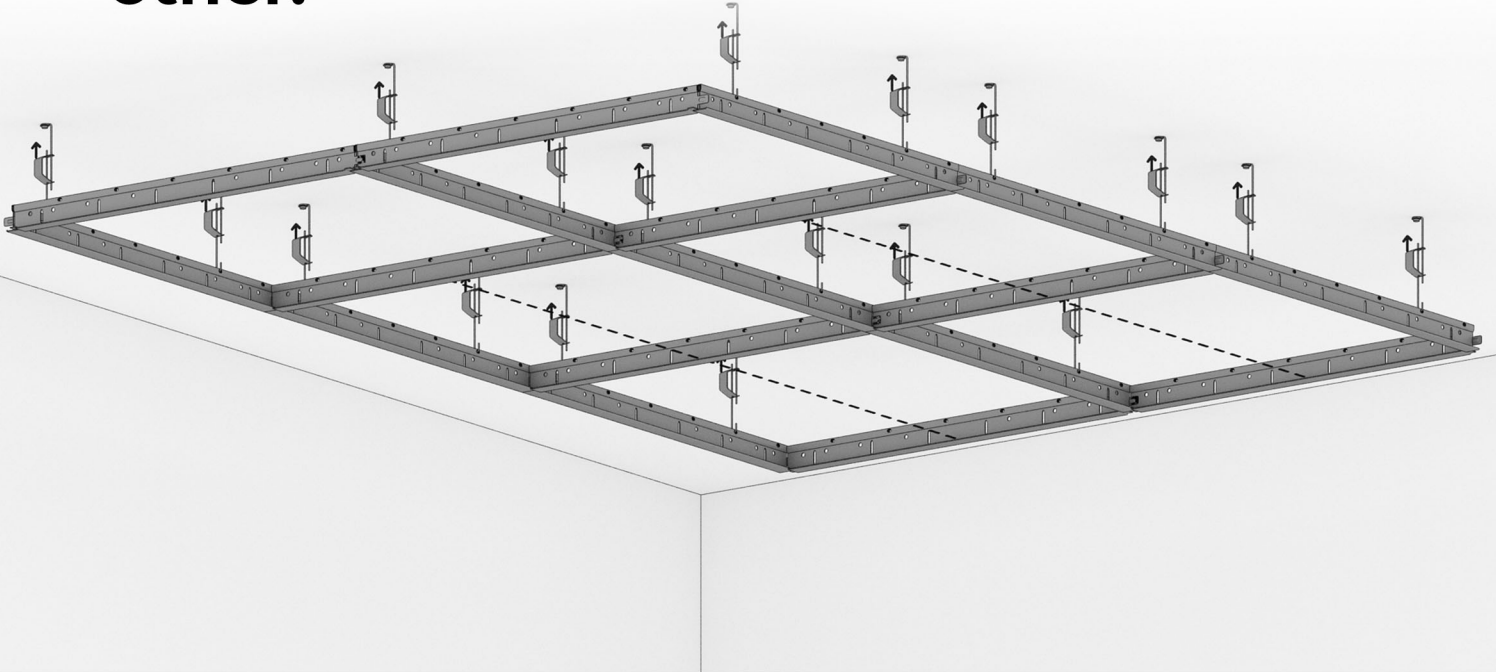

- ④ **Fold into a square frame.**

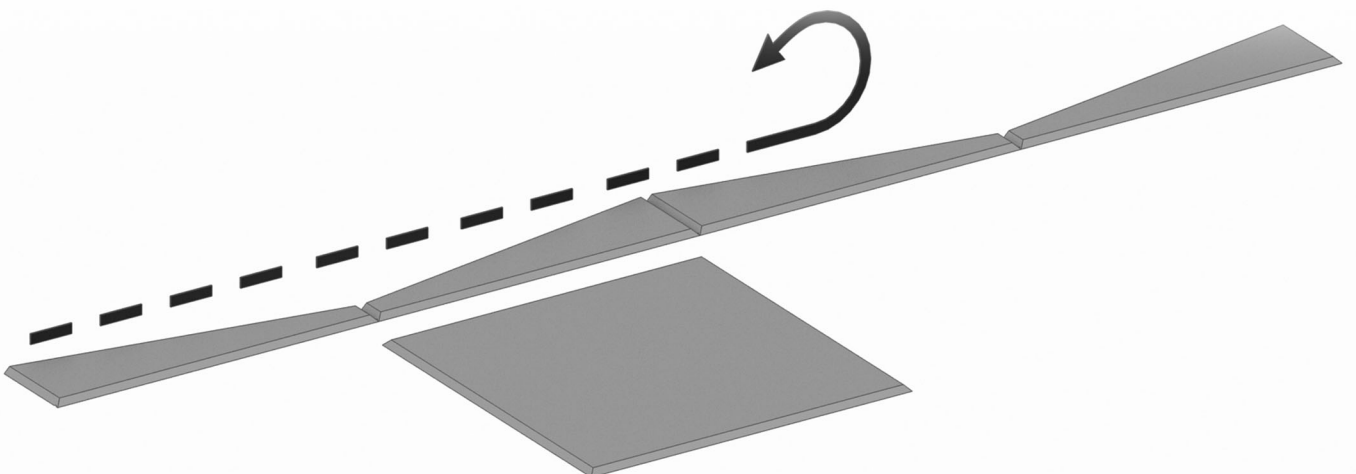

- ⑤ **The frame must be nailed to the T24 profile.**

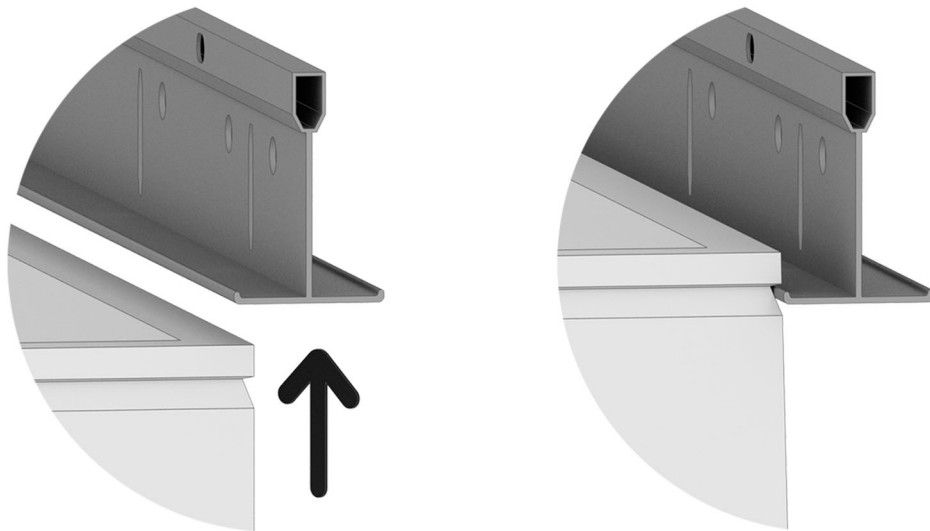

- ⑥ **Place the upper tile above the frame, also lying inside the frame itself.**

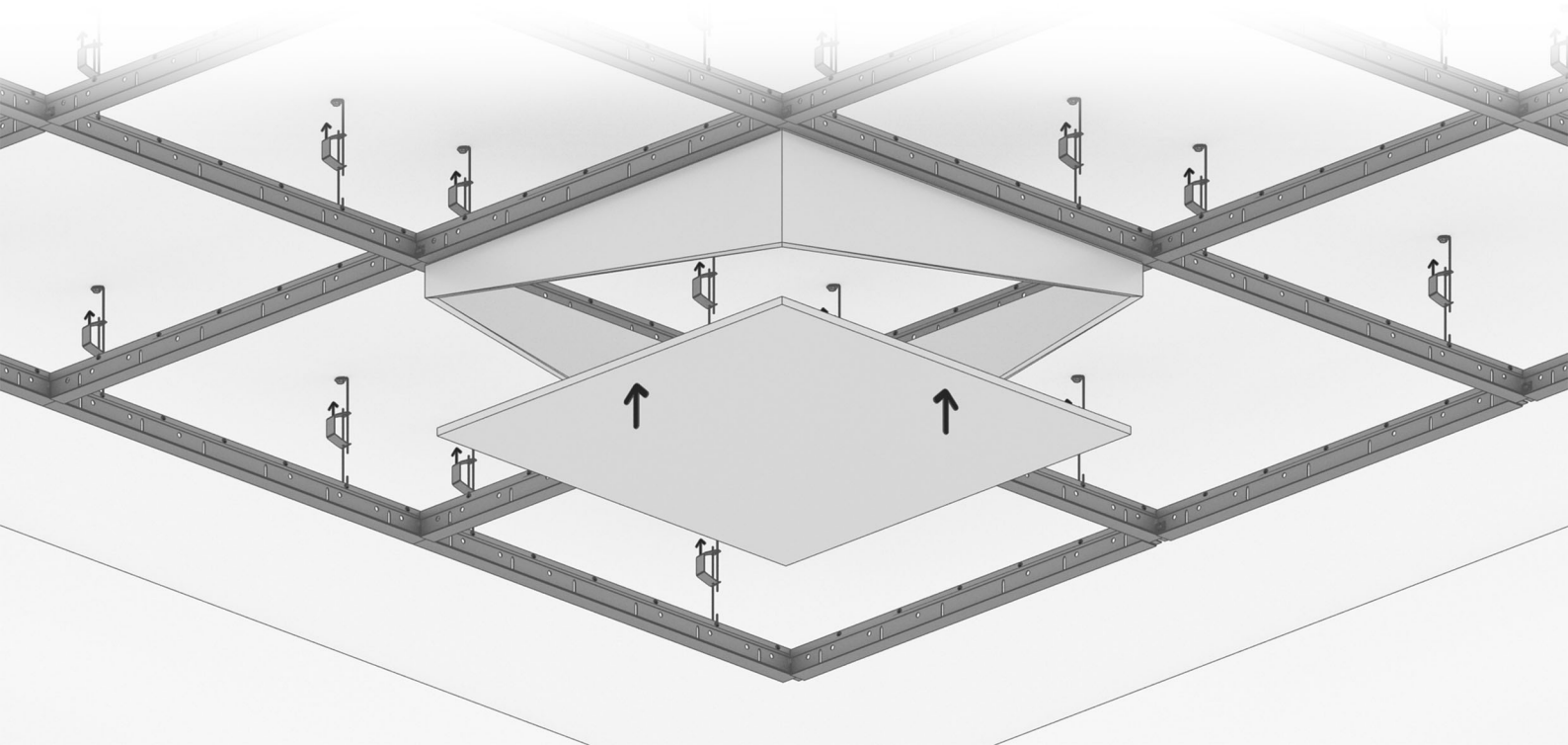

- ⑦ **Repeat the instructions for the entire ceiling.**

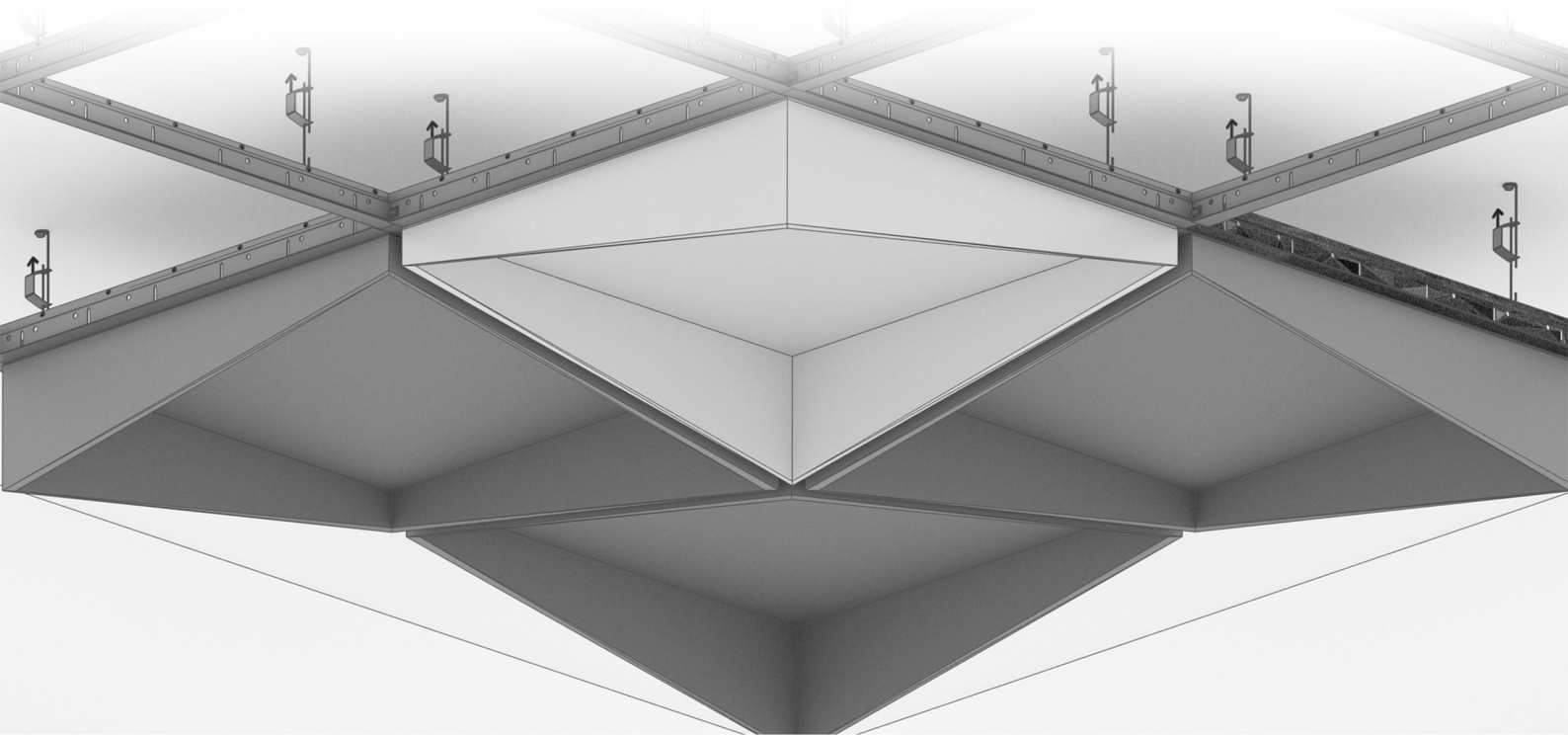



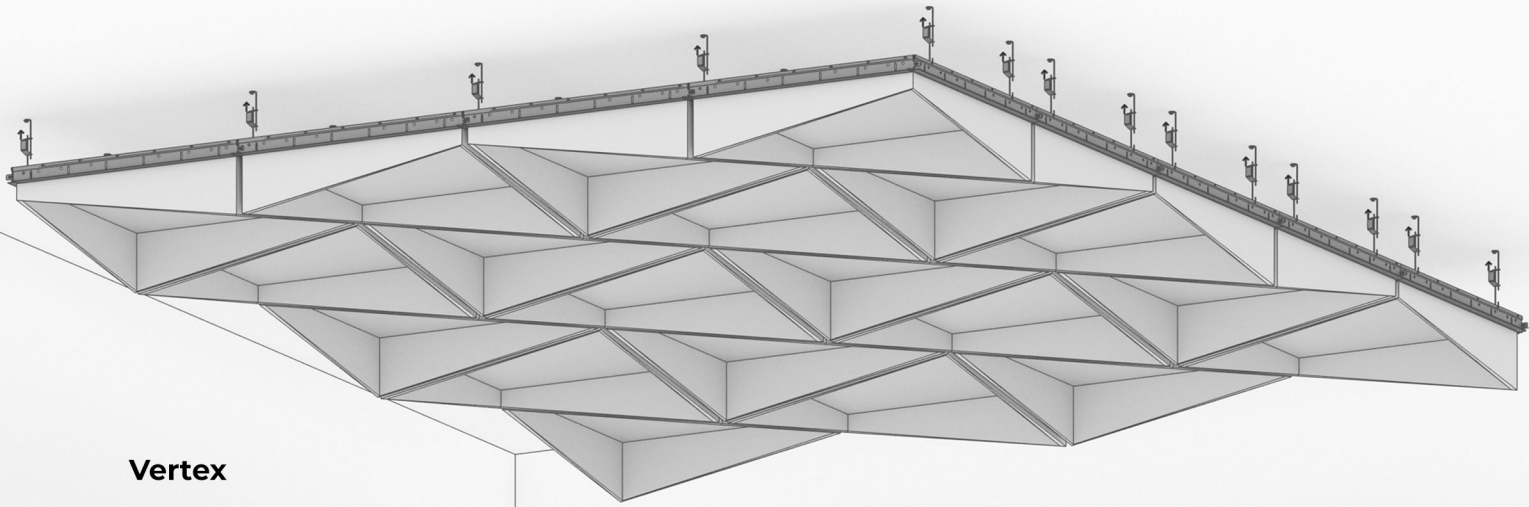

**Vertex**

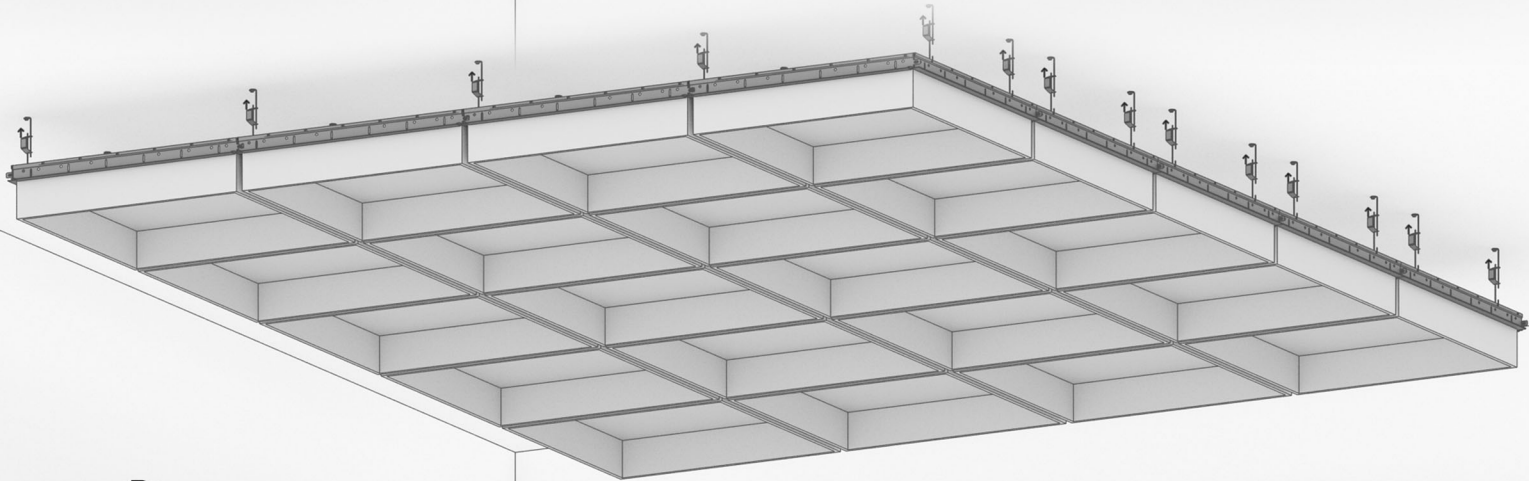

**Box**

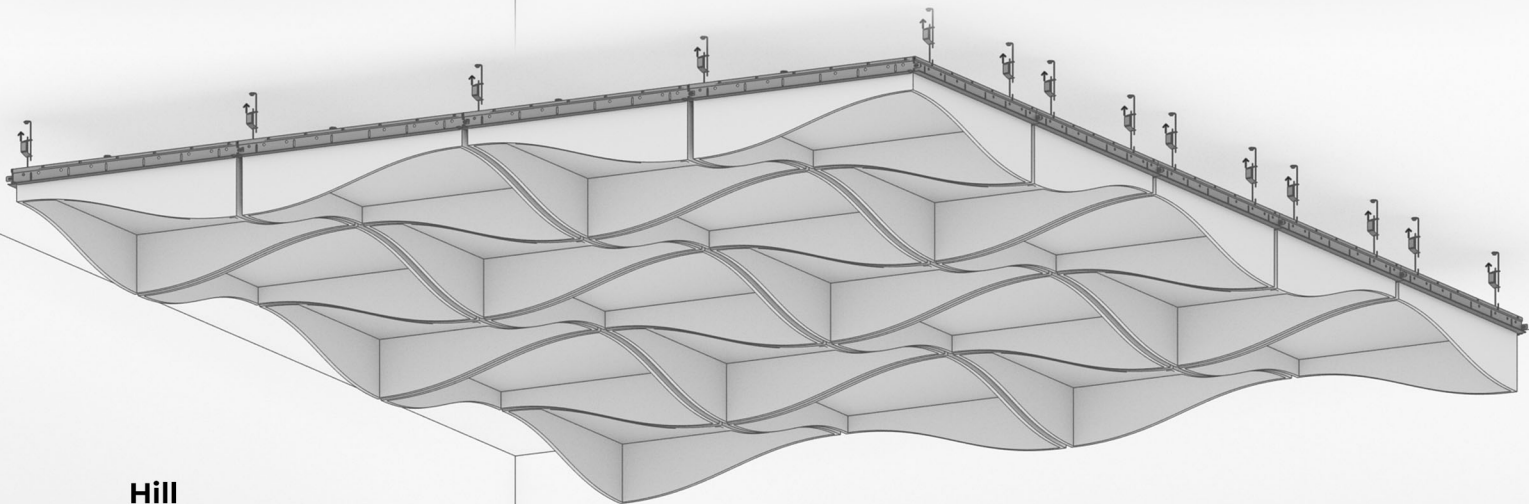

**Hill**