

Ecophon Focus F

600x600, 1200x600

M15

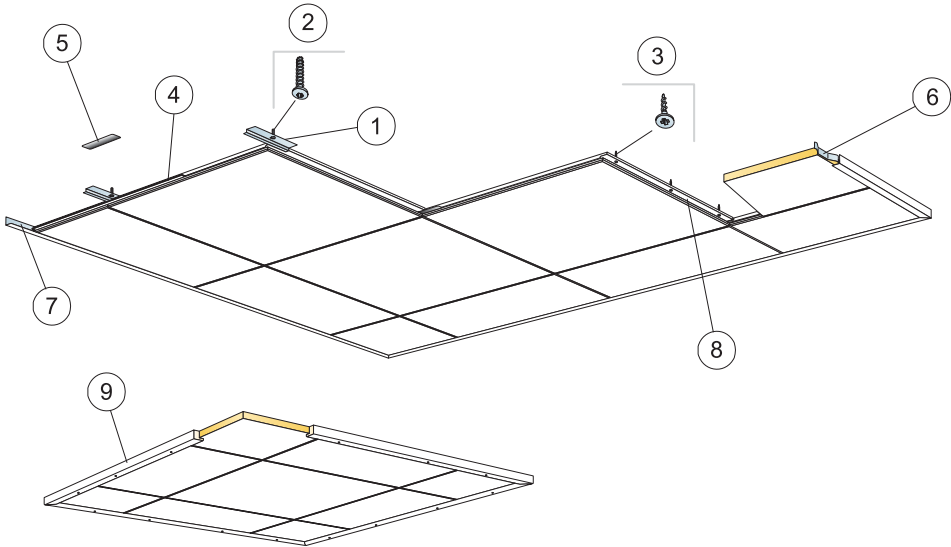

1. Connect Direct fixing plate F 0149, installed at 600 mm centres (for use in concrete)

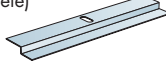

2. Connect Anchor screw 4000, installed at 600 mm centres (for use in concrete)

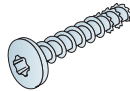

3. Connect Installation screw MVL, installed at 200 mm centres (for use in plasterboard or timber)



4. Connect Spline F, L=600 mm. Must be used in Sweden, Denmark, Norway and Finland at fireclass "Tändskyddande beklädnad"

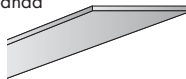

5. Connect Spline 0219, L=150 mm



6. Connect Wall spring spacer 0087



7. Connect Angle trim, fixed at 300 mm centres

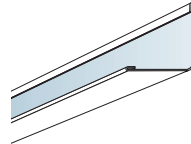

8. Timber installed at 600 mm centres (300 mm if thermal insulation is placed above), with the screw fixings along the timber.

9. For use when installing floating ceilings: Connect Wood trim 2561, L=2500 mm, fixed at 500 mm centres

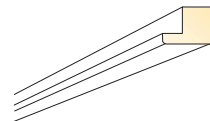

1

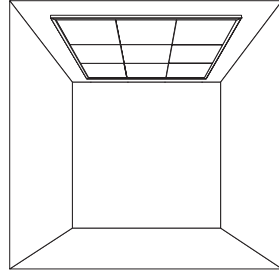
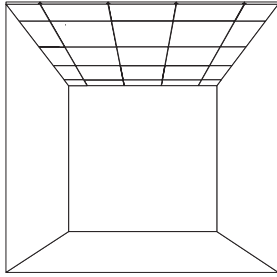

2



19

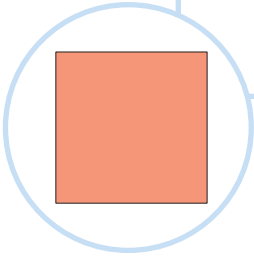

2

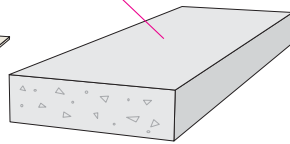
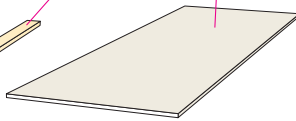
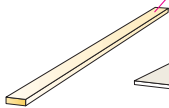
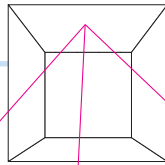

3





4

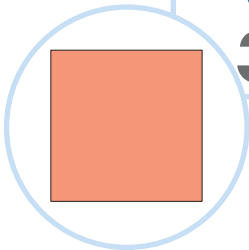

4

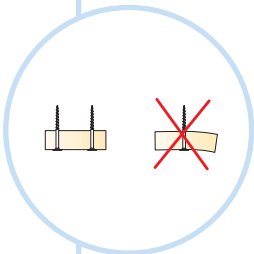
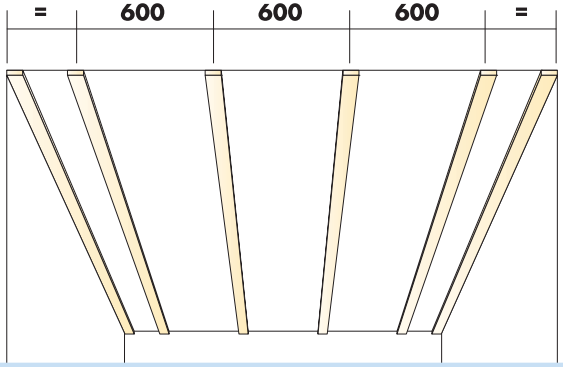
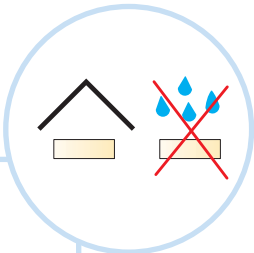
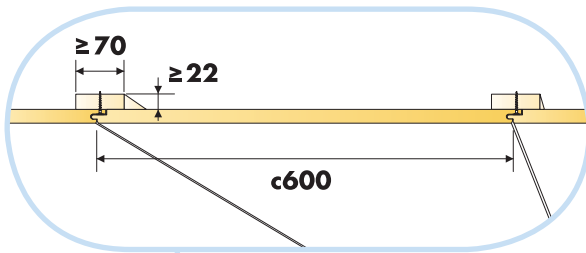



 **3**

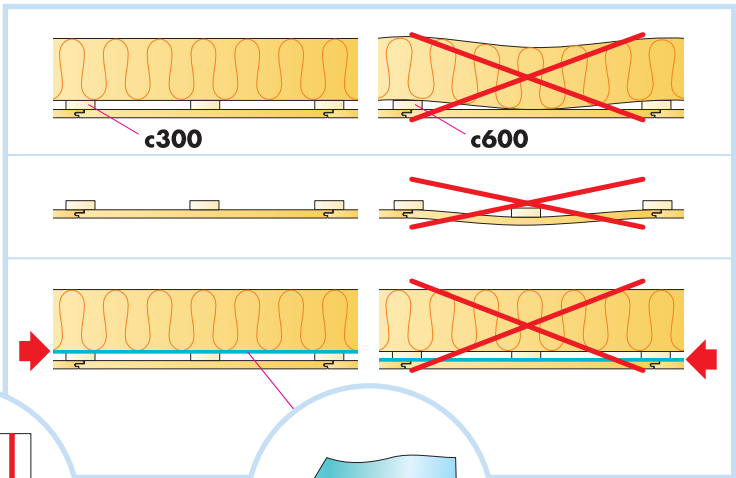
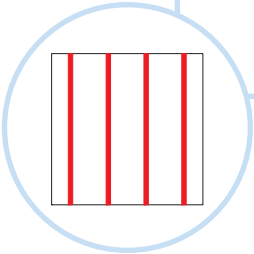

 **3'**

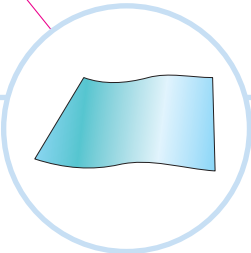
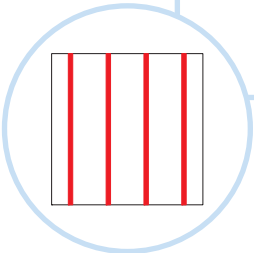

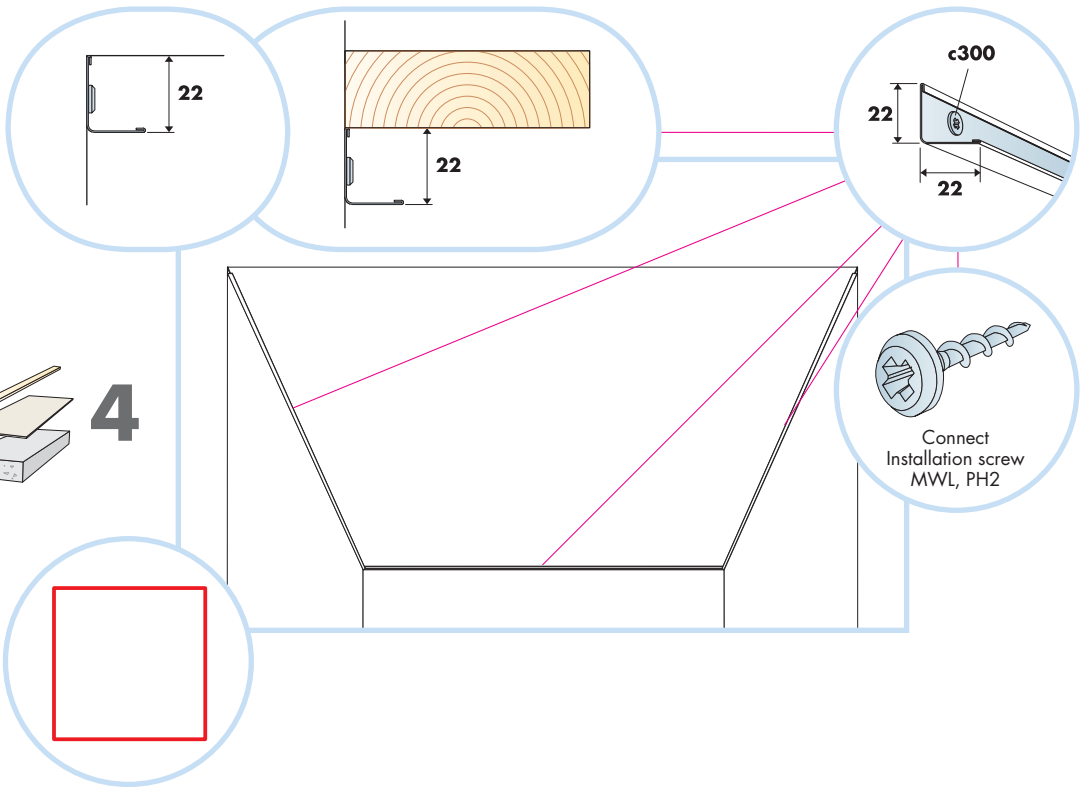

600x600

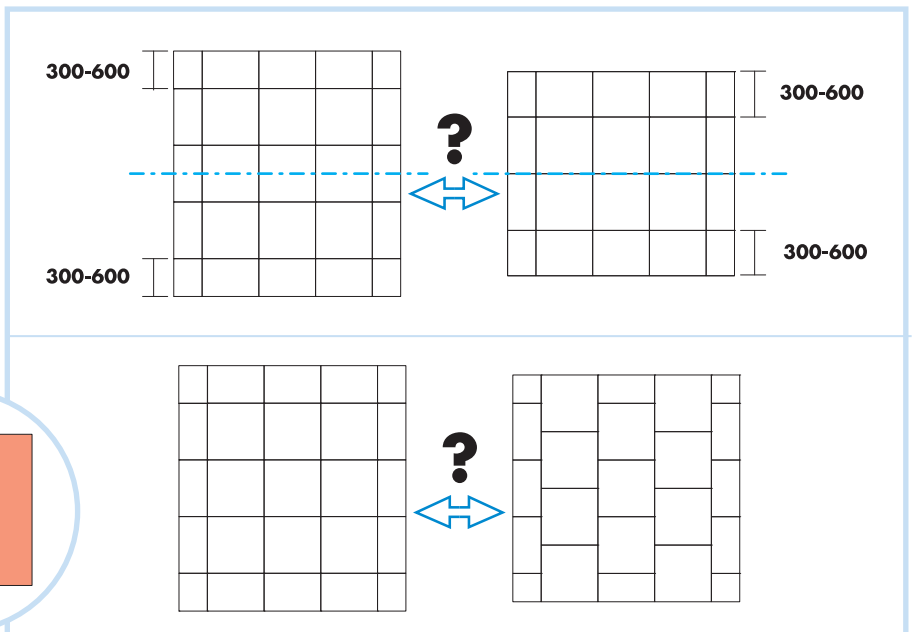
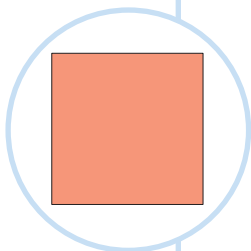
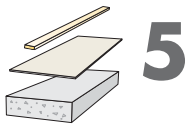

1200x600

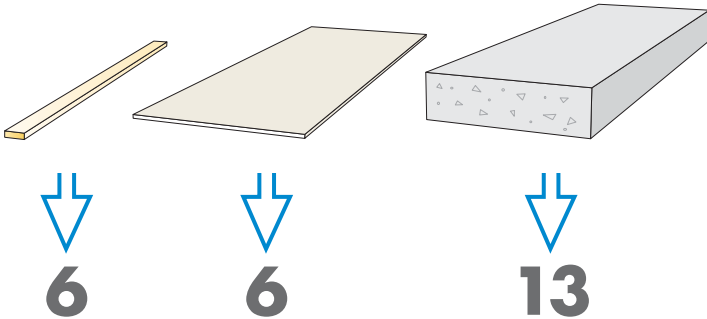
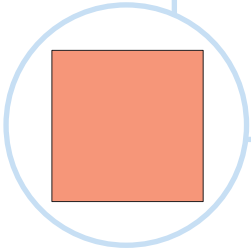
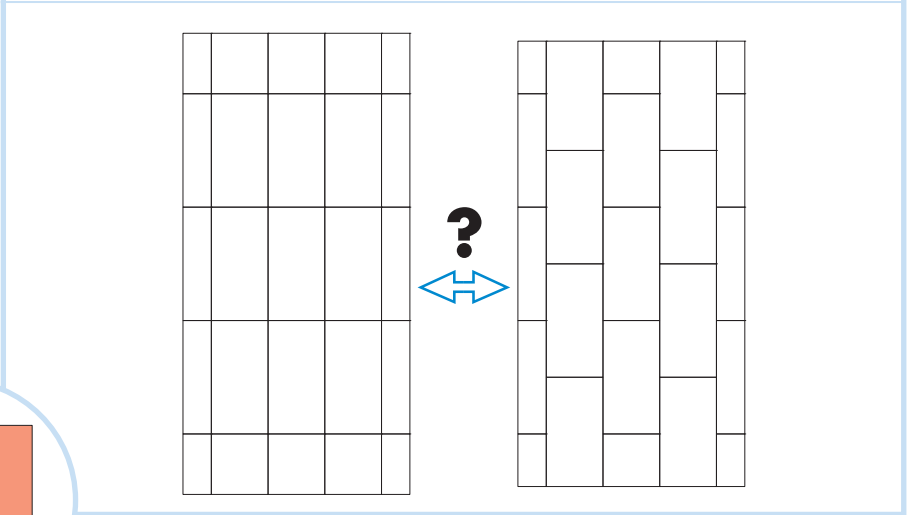
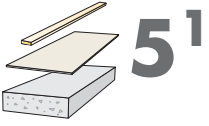
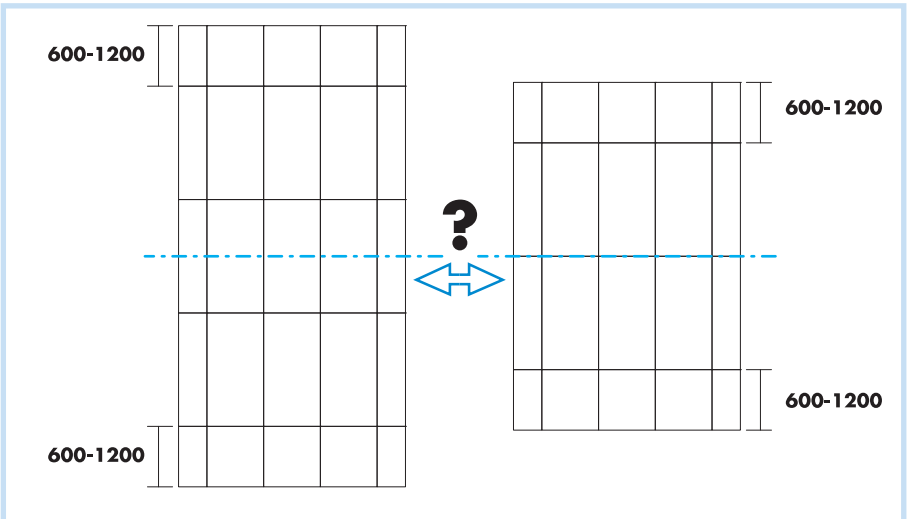

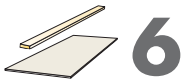
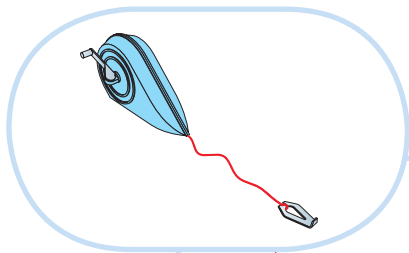

6

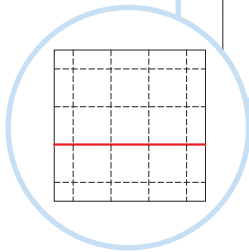
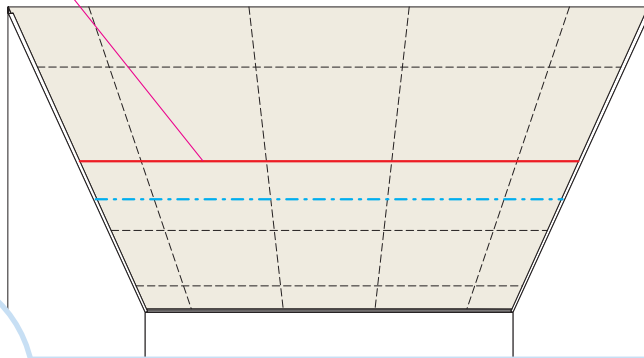

B=600

B=1200

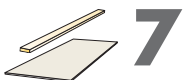
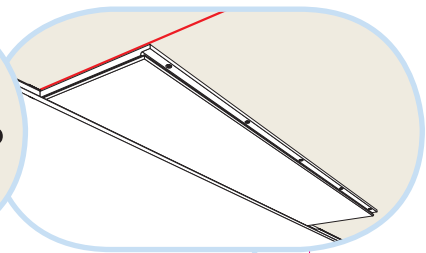
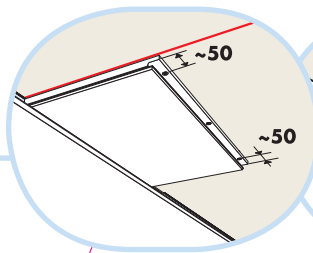
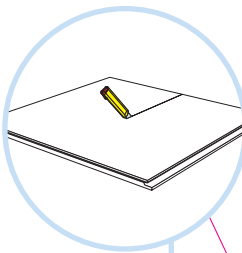

7

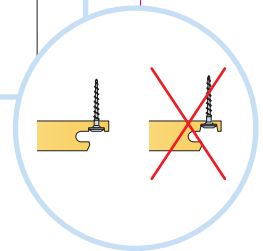
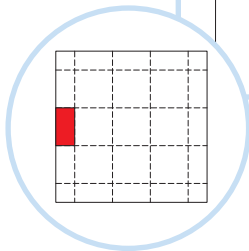
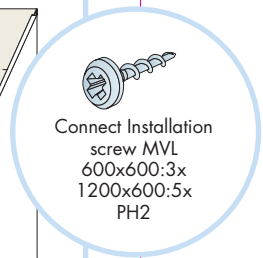
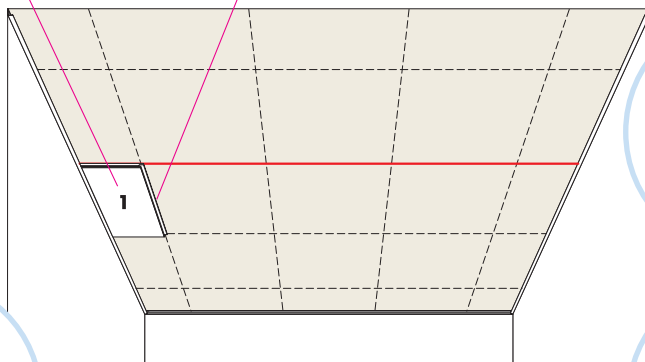

Connect
Spline 0219

Connect
Spline F

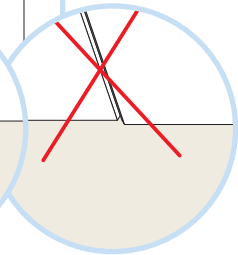
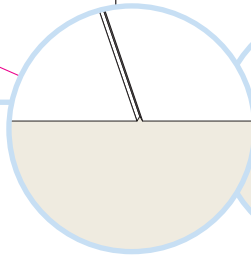
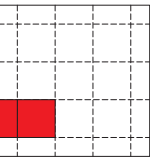
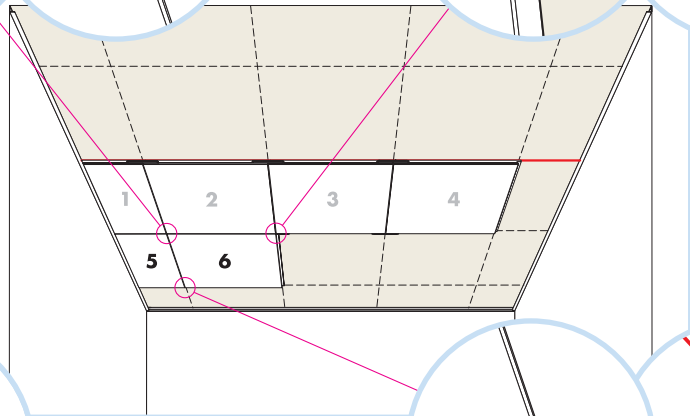
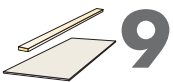
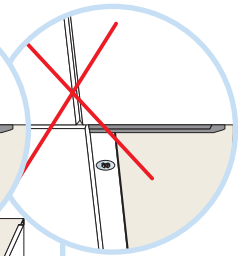
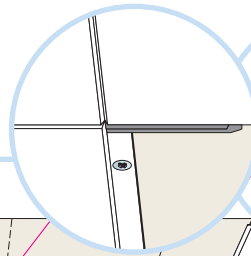
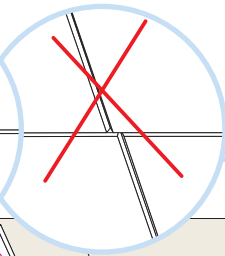
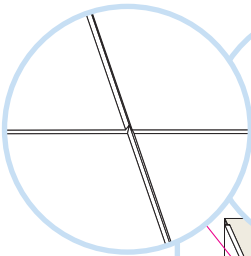
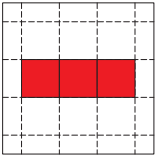
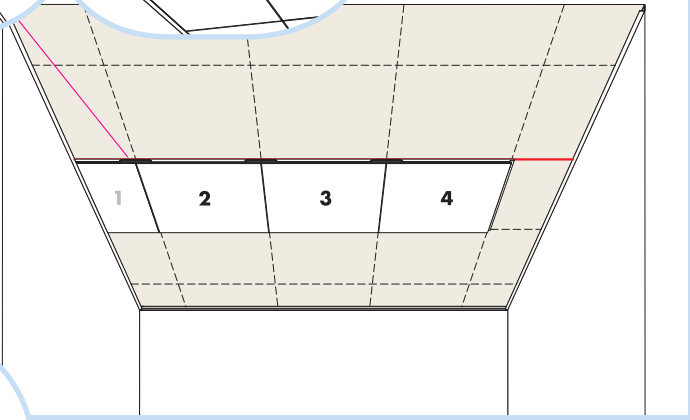
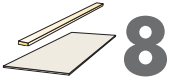

 **10**

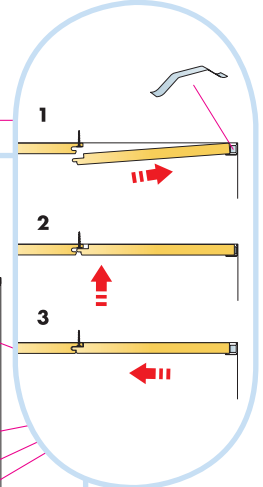
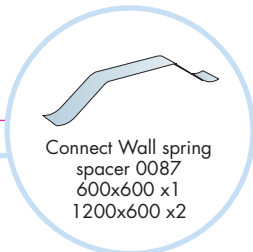
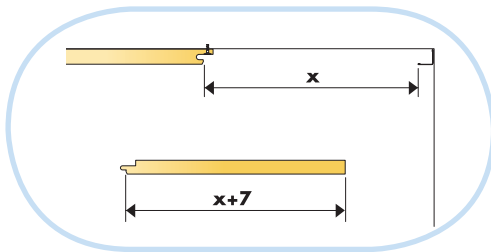
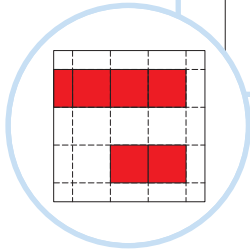
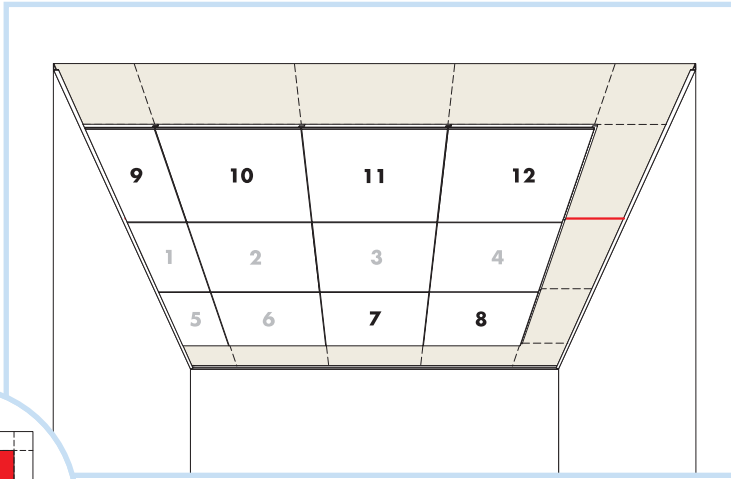

 **11**

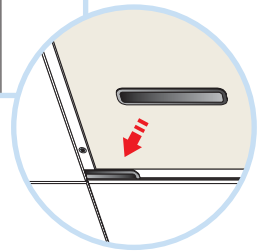
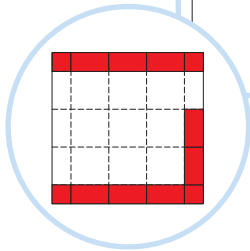
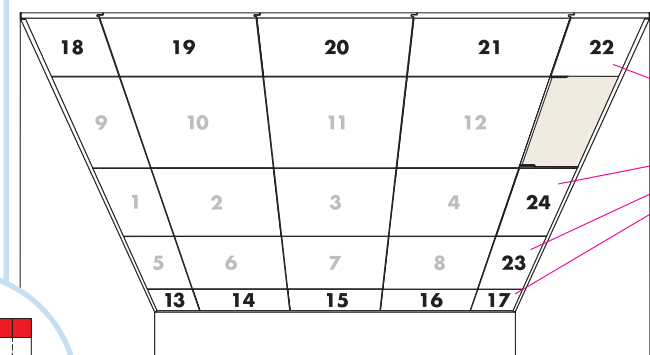

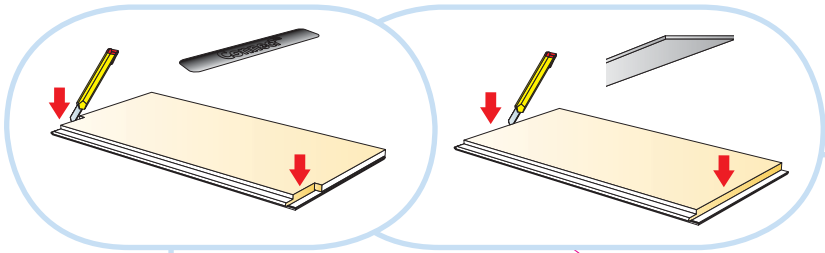

12

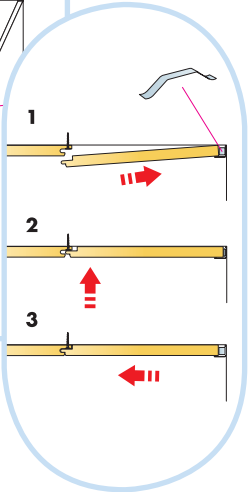
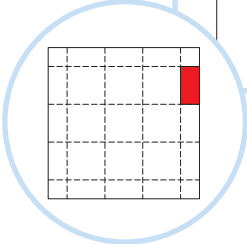
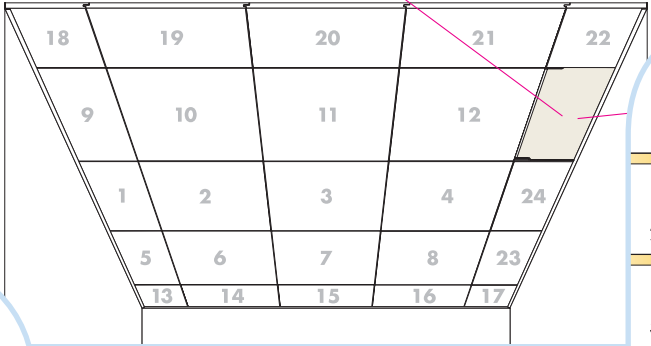

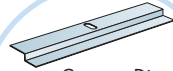
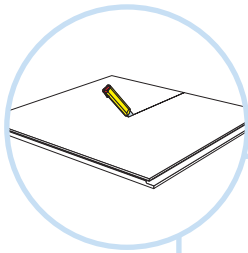

Connect Direct
fixing plate F0149



Connect
Installation screw
F4000

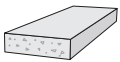
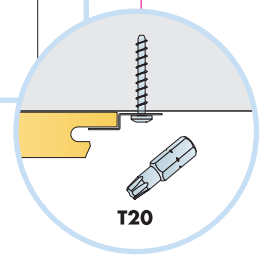
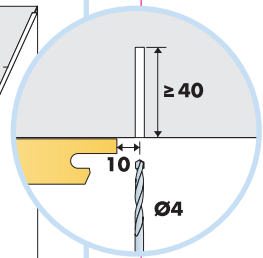
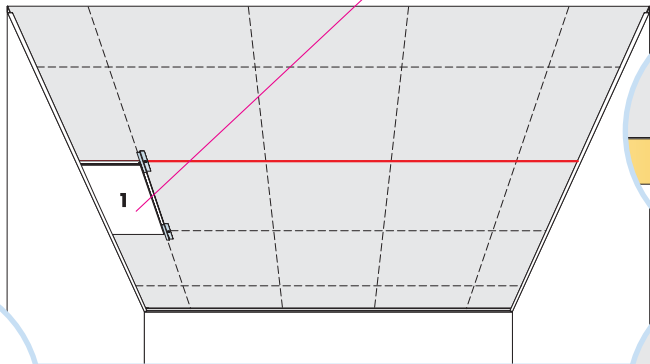
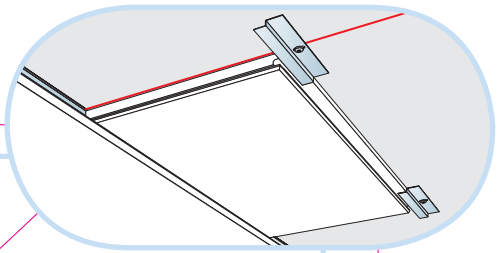

13

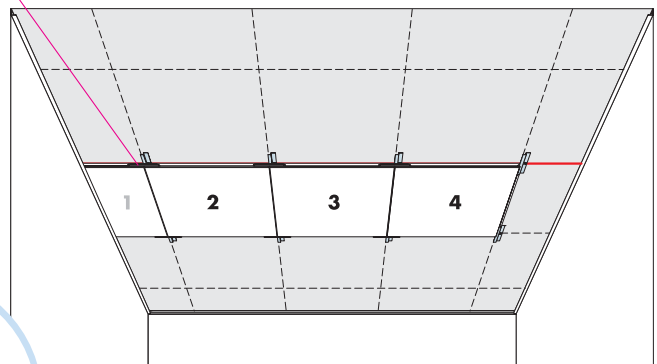
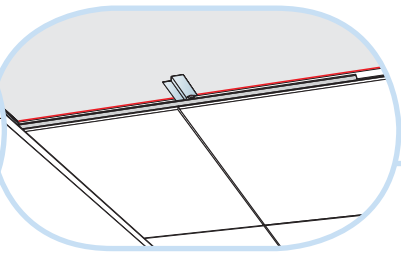
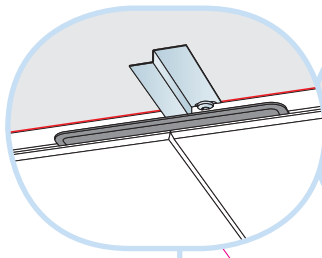
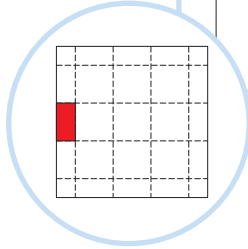

14

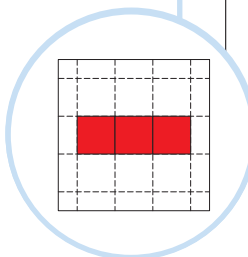

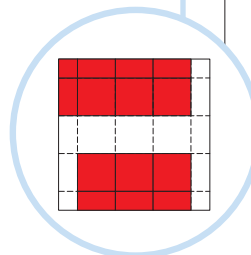
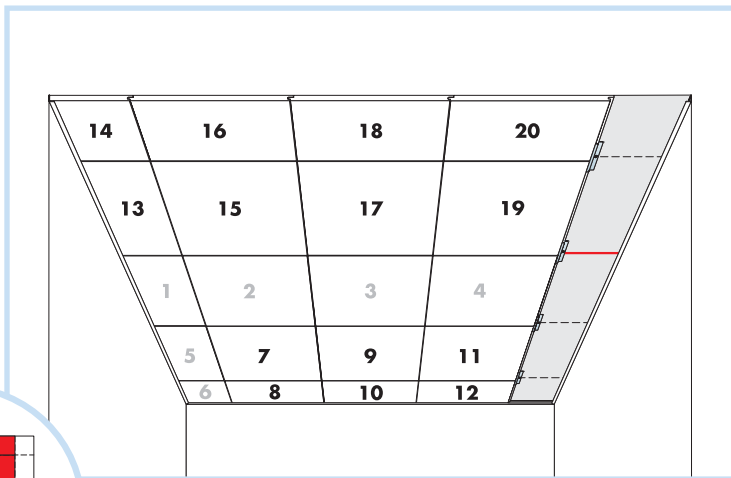
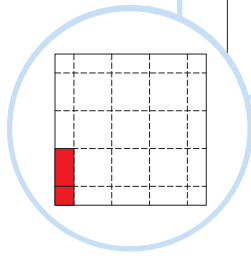
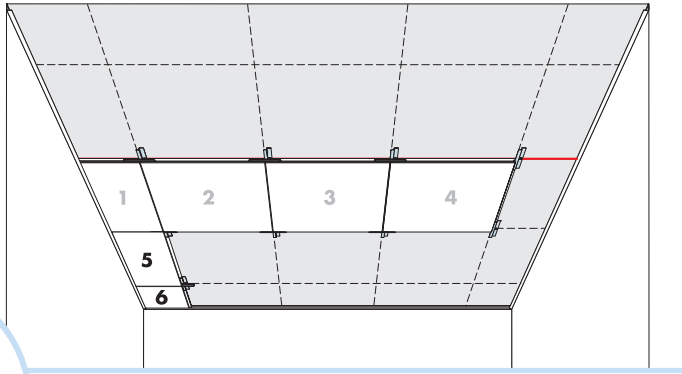
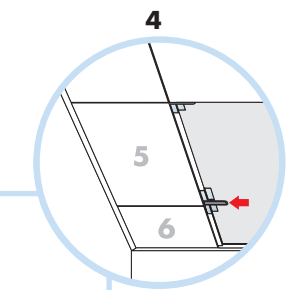
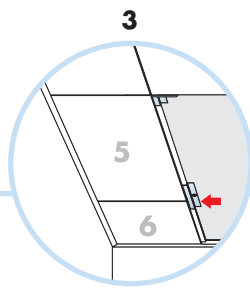
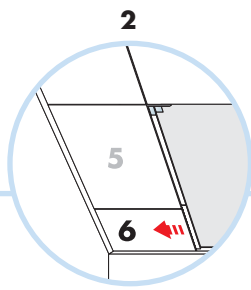
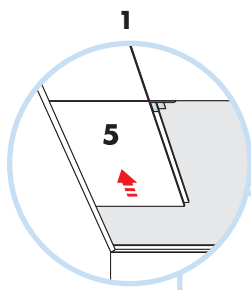

17

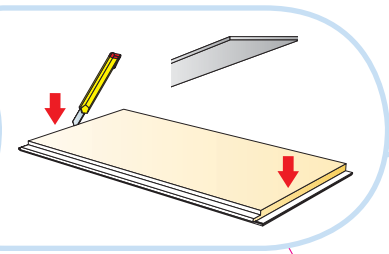
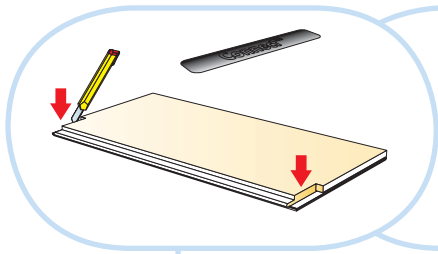
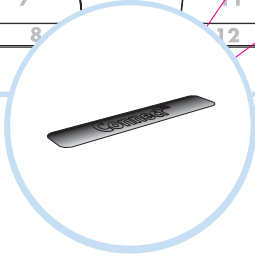
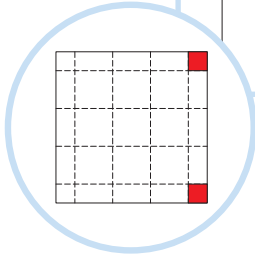
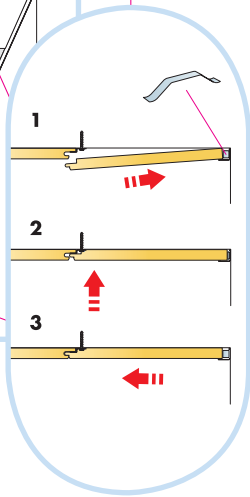
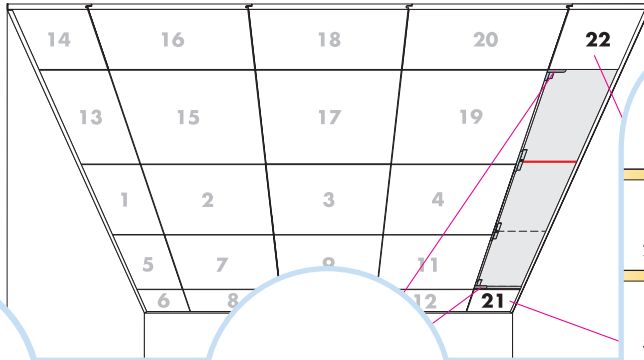
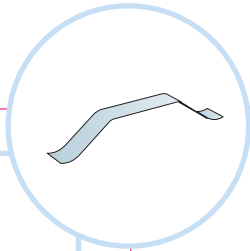
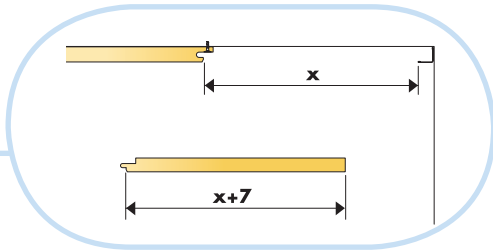
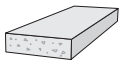

18

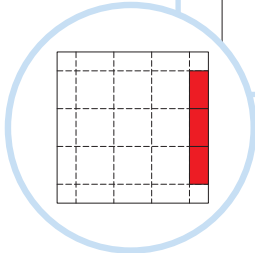
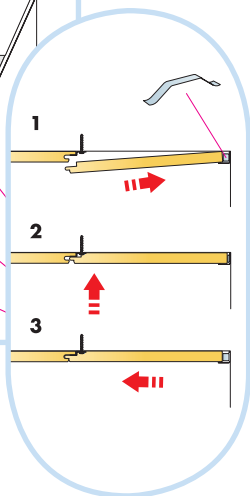
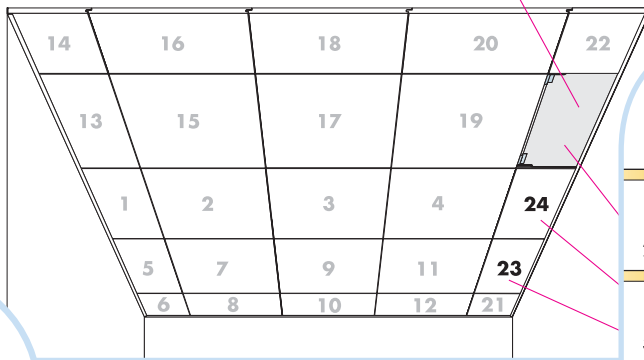
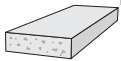

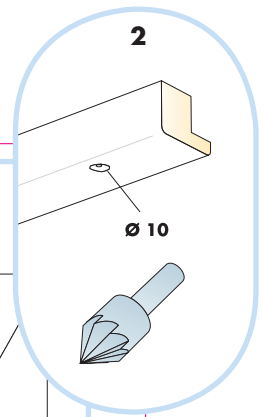
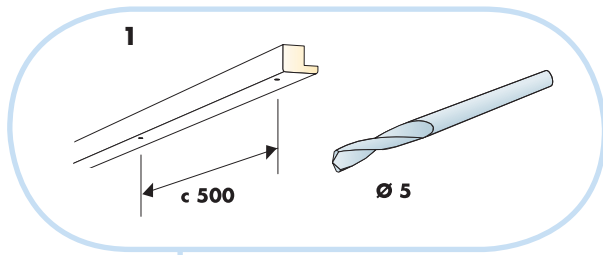

19

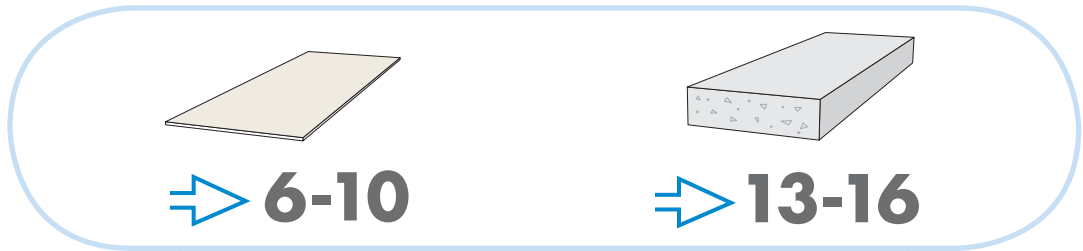
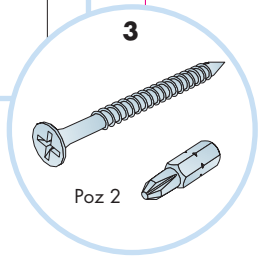
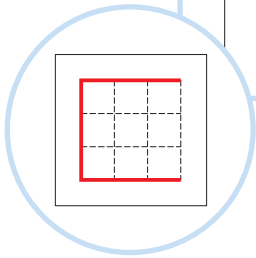
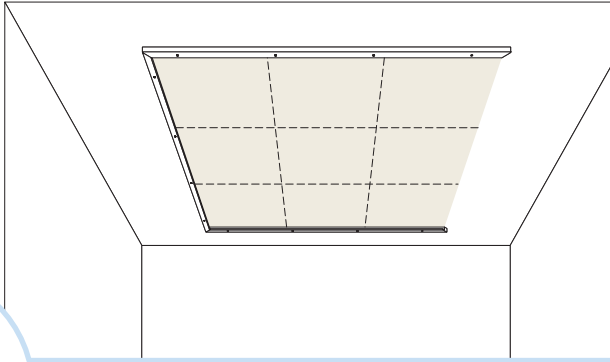

20

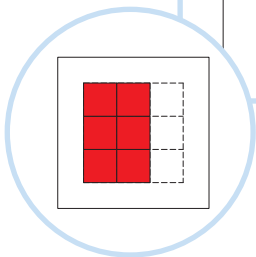
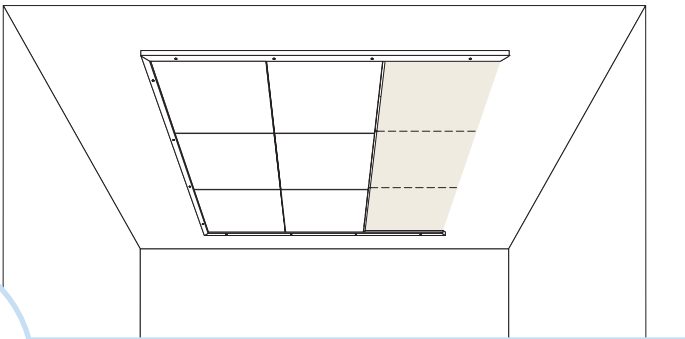

21

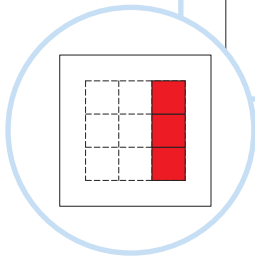
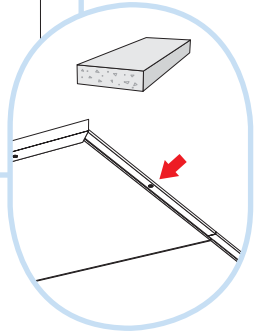
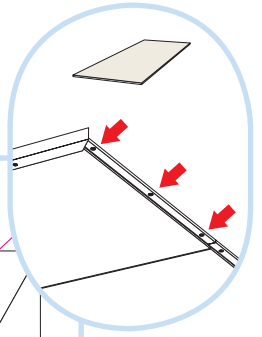
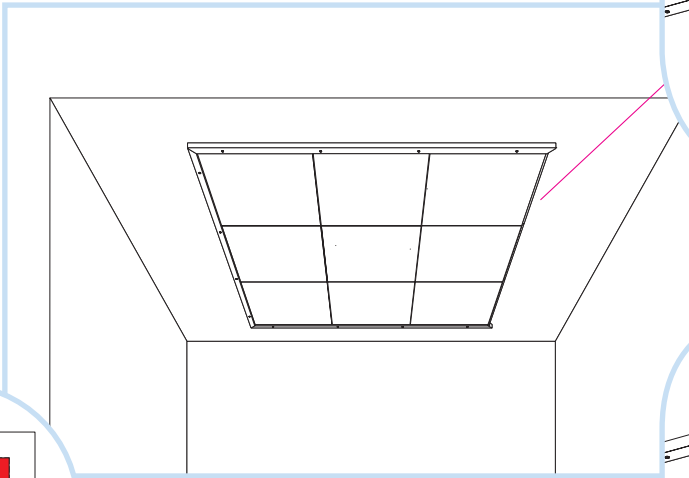

22

